

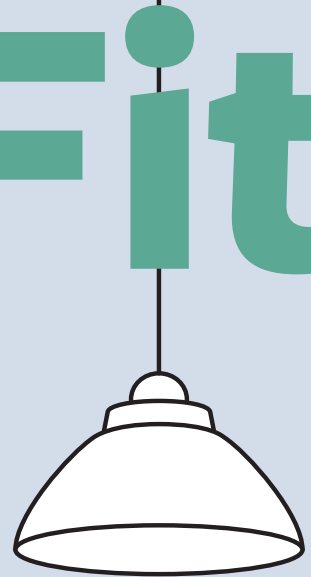

HomeFit Guide

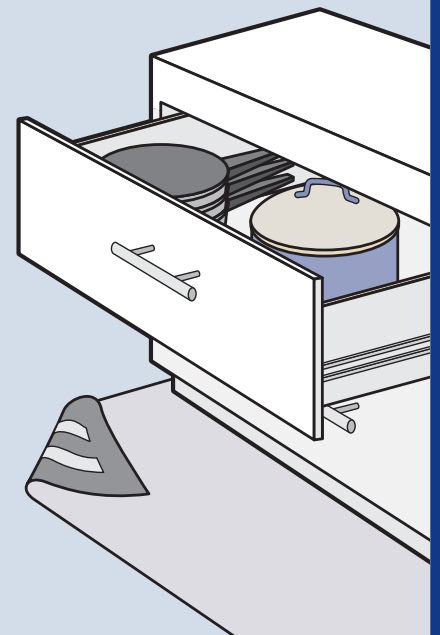

Smart ways to make
a home comfortable,
safe and a great fit
for older adults —
and people of *all* ages





AARP is the nation's largest nonprofit, nonpartisan organization dedicated to empowering people 50 or older to choose how they live as they age. With nearly 38 million members and offices in every state, the District of Columbia, Puerto Rico and the U.S. Virgin Islands, AARP strengthens communities and advocates for what matters most to families, with a focus on health security, financial stability and personal fulfillment.

AARP 601 E Street NW, Washington, D.C. 20049

Website: AARP.org

Phone: Toll-Free: 1-888-OUR-AARP (1-888-687-2277)

Toll-Free Spanish: 1-877-342-2277

International Calls: +1-202-434-3525

TTY user dial 711 (English: 1-877-434-7598 | Spanish: 1-866-238-9488)



The first edition of the *AARP HomeFit Guide* was published in 2010, having originated from a program created by AARP Michigan. Its focus was on the ways older adults could modify their homes in order to safely age-in-place. Over time, the guide has expanded to encourage people of all ages to think about and implement the types of improvements and features that can make where they live a lifelong home. The *AARP HomeFit Guide* is now part of the AARP Livable Communities initiative, which supports the efforts of local leaders and residents throughout the nation to make their communities more livable and age-friendly.

Website: AARP.org/Livable

Email: Livable@AARP.org

Facebook: @AARPLivableCommunities

Twitter: @AARPLivable

Free Newsletter: AARP.org/LivableSubscribe or text the word LIVABLE to 50757

Copyright © 2020 by AARP | AARP is a registered trademark. All rights reserved. No part of this publication may be reproduced in any form or by any means without the prior written permission of AARP, except brief quotations in connection with reviews written specifically for inclusion in magazines, newspapers or websites, or limited excerpts strictly for personal use.

Limit of Liability/Disclaimer of Warranty: While AARP has used its best efforts in preparing this publication, it makes no representations or warranties with respect to the accuracy or completeness of the contents, examples, instructions and/or guidance contained herein. The advice and strategies discussed may not be suitable for each reader's or community's situation. Consultation with local professionals is advised, and compliance with local regulations is required. AARP shall not be liable for any loss of profit or any other commercial damages, including but not limited to special, incidental, consequential, or other types, nor for any injuries to persons or property.

AARP HomeFit Guide

Smart ways to make a home comfortable, safe and a great fit
for older adults — and people of *all* ages

What if a home could be suitable for any resident, of any age or physical ability? What if an older adult who wants to live independently despite changing abilities or evolving needs could do just that?

The **AARP HomeFit Guide** was created to help people live safely and comfortably in their home by enabling where they live to be a “lifelong home,” suitable for themselves and others in their household, no matter a person’s age or life stage.

The **AARP HomeFit Guide** can help individuals and families make their current or future residence age-friendly. In addition, elected officials, policymakers and local leaders can learn about and advocate for the types of housing features and designs that communities need so their residents can live safely and comfortably — and thrive.

Contents

- 2** A ‘HomeFit’ Home Fits People of All Ages
- 4** Entrances and Exits
- 6** The Foyer
- 8** The Kitchen
- 11** The Dining Area
- 12** The Living Room
- 16** Hallways and Stairways
- 18** The Bedroom
- 20** Closets
- 22** The Bathroom
- 24** The Laundry Area
- 26** The Garage
- 28** Outdoor Places and Shared Spaces
- 30** Home Safe Home
- 32** Quick Fixes and Harder To-Do’s

A ‘HomeFit’ Home Fits People of All Ages

Most houses and apartments are designed for young, able-bodied adults and don’t meet the needs of older residents or people with disabilities.

In fact, in many parts of the United States, most housing units were built more than a generation ago to serve a population of family households, generally consisting of two parents and at least two children.

But America circa 2020 is a nation in which the dominant household type, accounting for nearly 30 percent of all households, consists of single adults living alone.¹ Another 20 percent of Americans reside in a home that’s occupied by three or more generations (a grandparent, an adult child and a grandchild) under one roof.²

By 2030, one in five people in the U.S. will be age 65 or over. And it’s projected that by 2034, such older adults will outnumber children under 18 for the first time ever.³

AARP surveys consistently find that older adults want to remain in their current homes and communities for as long as possible. But America’s housing stock doesn’t fit its rapidly changing and rapidly aging population.

Barely 1 percent of the nation’s housing supply contains any “universal design” elements — such as single-story living or a sink that can be reached from a wheelchair.⁴

Having a no-step way for getting into or out of a home clearly benefits older residents and people who use a wheelchair. But a step-free entrance also helps a parent who’s pushing a stroller, or a teenager with a sports injury, or anyone carrying heavy grocery bags.

The reality is, few people have the resources to build their perfect home. And it isn’t realistic to expect that a broad enough variety of housing will be built soon enough to meet the nation’s diverse and changing needs.

That’s where the *AARP HomeFit Guide* comes in.

When possible, “home-fitting” should take place *before* easier-to-use home spaces and features become must-haves.

The *AARP HomeFit Guide* examines what makes a home aging-friendly. And it suggests the kinds of designs and modifications that can make a home safer, more comfortable and a better “fit” for its residents — of every age.

¹ AARP and the National Building Museum, *Making Room: Housing for a Changing America* | [AARP.org/Making Room](https://www.aarp.org/making-room) (2019)

² Pew Research Center, “A Record 64 Million Americans Live in Multigenerational Households” (April 5, 2018)

³ U.S. Census Bureau, “Older People Projected to Outnumber Children for the First Time in History” (October 8, 2019)

⁴ U.S. Department of Housing and Urban Development, “Meeting the Future Housing Needs of Seniors,” *PD&R Edge* (November 2017)

⁵ Community Aging-in-Place – Advancing Better Living for Elders (CAPABLE), Johns Hopkins School of Nursing

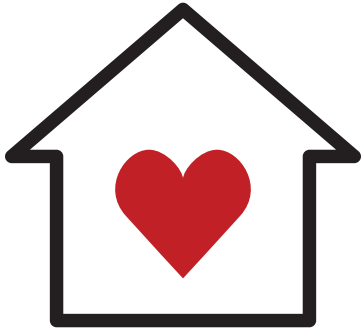

Home Sweet Home

The *AARP HomeFit Guide* is about *homes* not *houses*. While a single-family detached house is a home, so is a town house and an apartment and a mobile home. Most of the suggestions in the guide are doable regardless of home type or ownership status. However, renters will likely need to seek permission from the property owner for changes that require remodeling or installation work. (Know that fair-housing and accessibility laws tend to favor the requests of renters seeking reasonable accommodations. See page 29 to learn more.)



Home Safe Home

The *AARP HomeFit Guide* addresses a range of household hazards and safety solutions. Although the phrase “home security” typically refers to an alarm system that protects a residence and its occupants from intruders, a safe and secure home protects residents from other risks, including fire, carbon monoxide poisoning, slips and falls. Research shows that home modifications — even ones as small as installing night-lights and lamp timers — can reduce the need for costly medical care, increase the ability of older adults to manage activities of daily living, and enhance independence.⁵



Home Smart Home

Technology and how it’s used in homes has changed greatly since the *AARP HomeFit Guide* was first published a decade ago. When a later edition of the guide was produced in 2015, fewer than 5 percent of U.S. households routinely used “smart home” systems — i.e., internet-connected appliances, thermostats, speakers, door locks. This edition contains information (on page 14 and elsewhere) about the ways home technology can improve residents’ comfort and independence.

Entrances and Exits

Whether a residence is a house or an apartment, its exterior doorways should allow a smooth transition into and out of the property. Many homes have entrance steps, which can make the dwelling inaccessible to a person who uses a wheelchair, relies on crutches or has difficulty climbing stairs.

The ideal is for all homes to have at least one zero-step exterior doorway. If step-free access isn't possible for the front of the home, a side door, back door or door located inside the garage may be a suitable substitute. Another solution is a ramp. (Learn more about that option on page 28.)



FOLLOW THE NUMBERS

1. For exterior doorways, an **overhang** — to protect from rain, snow, sun — is a plus, as is a stoop or porch with room enough for sitting.

2. **Outdoor lighting** is a safety must. It's helpful for at least one entryway light to be placed at a height that doesn't require a ladder when changing the bulb.

3. The “clear width” of a **doorway** opening should be at least 32 inches to allow for a wheelchair to pass through. When the measurement is just an inch or so too small, swing-clear hinges can provide the needed space. (To see how such hinges work, search online for “swing-clear,” “wide-throw” or “offset hinges.”) The “clear height” of a door opening should be at least 80 inches.

4. If a door doesn't have a glass panel and there isn't a window nearby, a **peephole** can help residents see who's outside before opening the door. If the height isn't suitable for all users, two peepholes — one for tall residents, the other for shorter adults, wheelchair users or children — might be needed.

5. The keyed **door lock** should be separate from the door handle. (See below for more about locks.)

6. A **lever-style door handle** is easier to use than a doorknob or thumb-latch handle. (And that's especially true for people with arthritis or when hands are full.)

7. A **video doorbell** can often be paired with a smartphone app, enabling a door to be answered remotely and a visitor identified whether or not anyone is home.

8. A visible **address number** helps delivery people and first responders locate a residence. Numbers made of a shiny, reflective or glow-in-the-dark material are the most visible at night.

9. A heavy, solid-surface **doormat** is less likely to shift, result in uneven footing or, when used in an outdoor location, blow away in the wind.

10. Placing a piece of furniture, such as a table or **bench**, near the entrance door provides a useful spot for setting down items while locking or unlocking the door. The same furniture — or a nearby bin, box or basket — can be used by a mail carrier or delivery person for leaving a package if no one answers the door.

A Look at Locks

Different locks serve different purposes.

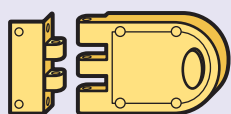

A **deadbolt or cylinder lock** is a strong device for securing a door. If a window is near enough for someone to break the glass and reach inside to turn the bolt, a double-sided keyed bolt is used instead. (If such a lock is installed, it's very important to keep a key inside the home and near the door so no one gets locked indoors without a way to get out.)

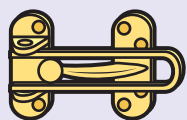

A **swing bar or chain lock** is installed on the interior of the door and allows a person inside the home to open the door a few inches — to speak with whoever is on the other side or to sign for a delivery — while keeping the door relatively secured.

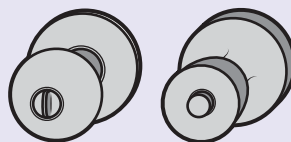
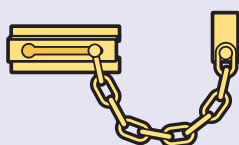

A **doorknob lock**, like the push-button or thumb-turn styles often used on bedroom or bathroom doors, isn't the best choice for an exterior door. The lock can too easily be pressed or turned, resulting in someone being accidentally locked out of the home.



A higher-tech solution for an entryway lock eliminates having to find or fumble with a door key. A battery-powered or hardwired **digital door lock** can be opened by using a code or a fingerprint. Some devices also work with a key, others provide a way to lock and unlock a door via a smartphone app or remote control.

The Foyer

Not every home has a large, formal foyer, but most homes have some sort of transition area just inside the entry door. That space should be free of clutter and, when there's room, provide storage for things carried (a handbag, backpack, briefcase, umbrella) or worn (shoes, gloves, a hat and coat). Objects strewn about can be hard to find — and easy to trip over.

FOLLOW THE NUMBERS

1. Although the names used to describe the space vary, professional home organizers suggest creating a **“command station”** or **“landing pad”** near a home’s most-used door. Equipped with a desk, table, credenza or wall-mounted shelving, this is the spot where the car keys can be kept, or the wallet placed, so time isn’t wasted searching for them. Outgoing mail can also go here — as can supermarket coupons, shopping totes and other items that are easy to forget when rushing out the door.

2. Many households have a shoes-off policy when inside. In many cultures, **shoe-and-slipper storage** is a must-have feature in the foyer, which is where outdoor footwear is removed and house slippers are put on. **TIP:** A supply of unisex slippers of varied sizes can be kept on hand for use by visitors.

3. Keeping a dual compartment **wastebasket** nearby helps with the immediate disposal of junk mail, much of which is recyclable. To guard against identity theft, shred any mail or papers that contain personal information. (See page 31 to learn about the AARP Fraud Watch Network, a free resource that helps people protect themselves from scams.)

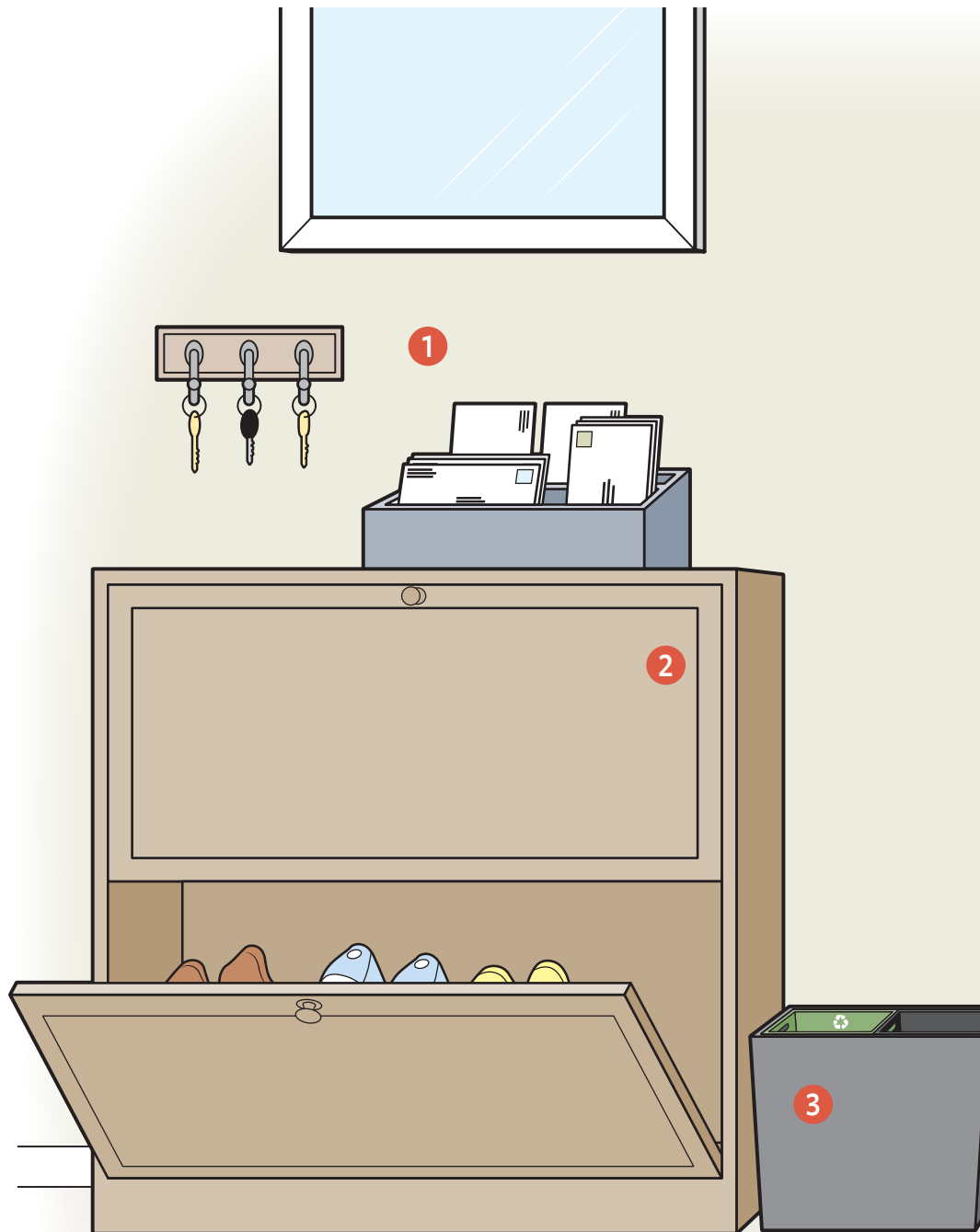

4. If a closet isn't located near the home's main door, a tall wardrobe cabinet, a no-tip coat rack or securely installed **wall hooks** can be used for keeping coats, jackets, handbags and backpacks within easy reach.



5. It's helpful to have a **place to sit** when putting on or taking off shoes. (A bench or chair is also handy for an adult who has to get shoes on and off of a toddler.) The space beneath a seat can be a spot for bins that hold shoes, slippers, hats and gloves. Dog owners might use a bin or wall hooks for storing a leash and other pet accessories.

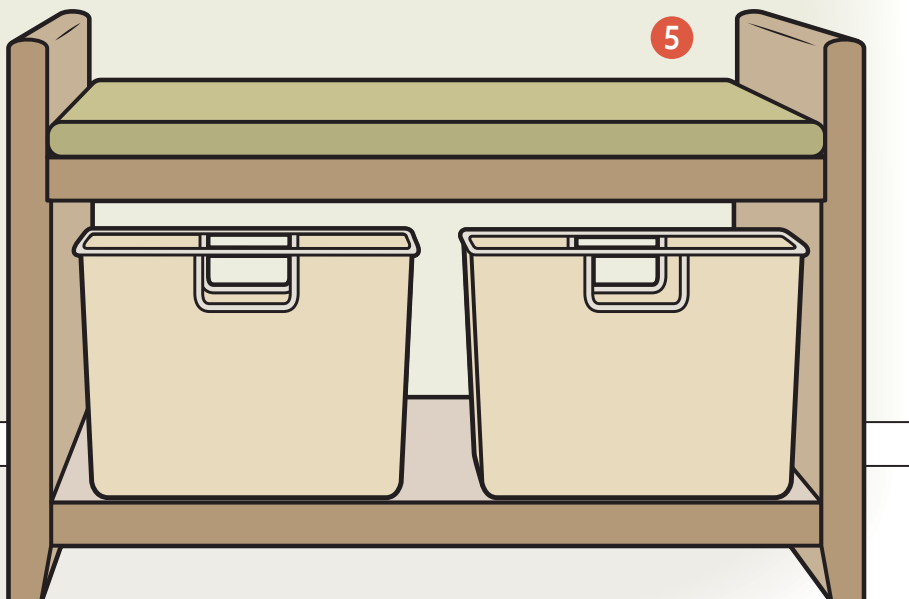

'Visitability' and 'Universal Design'

The terms refer to housing and building features that are designed for people who have a disability or mobility challenge.

According to *Visitability.org*, a website hosted by the National Council on Independent Living, a home is visitable if it meets three requirements:

1. It has a zero-step entrance.
2. The doorways provide at least 32 inches of clear passage space.
3. A bathroom is accessible by someone using a wheelchair.

But visitability can also mean that a grandparent's home is safely visitable by young grandchildren.

According to the Center for Inclusive Design and Environmental Access, Universal Design, or UD, "is a design process that enables and empowers a diverse population by improving human performance, health and wellness, and social participation."

However, the center adds, UD "is not a synonym for accessibility. Accessibility usually refers to minimum compliance with prescriptive codes and standards for people with disabilities. UD is performance-based and addresses usability issues for people of all ability levels."

The Kitchen

Regardless of how many rooms a home has, residents and guests tend to congregate in the kitchen (unless banished by the household chef). But even the most welcoming kitchen has its hazards. Fires, spills, slips, trips and drops can cause injuries and home damage. Home-fitting interventions can make the kitchen safer and easier to use for every diner, visitor and cook.

FOLLOW THE NUMBERS

1. A **wall cabinet** that covers the entire top of the refrigerator turns the space into usable (albeit not the most easily reached) storage.

2. A french-door **refrigerator** opens in the middle, which makes it easier to see and reach what's inside. The external drawer can store small, frequently used items. The bottom freezer typically contains an easy to access upper basket and a lower bin.

3. D-shaped **handles and drawer pulls** are easier to grasp than knobs.

4. Lower-level cabinets with **pullout shelves** are easier to see and reach into than those with stationary shelving. Cabinet manufacturers and home improvement stores sell kits for adding sliding bins and shelves. **TIP:** Frequently used items are best stored between hip and shoulder height.

5. The top oven in a **double-oven range** can be used to prepare small meals. And the height is helpful if bending and lifting is difficult. **TIP:** Unlike a traditional microwave oven, a convection microwave is suitable for baking and roasting. For some households, the dual-function appliance can eliminate the need for a full-sized oven, especially if the kitchen contains a separate cooktop.

6. Controls at the front of a **range** save users from having to reach over hot burners and pots. Colored or backlit controls are the easiest to read. Controls that can be locked, covered or removed are useful if children live in or visit the home.

7. **Open shelving** makes items easier to see, reach and reshelve after use. Another plus: Exposed shelves eliminate the possibility of walking into an open door.

8. Not every **small appliance** needs to be kept on the kitchen counter. Items that are used daily — such as a coffee maker or rice cooker — might be worthy of countertop real estate. Since it's easy to forget to turn off a plug-in appliance, choose models with an automatic shutoff.

9. **Drawers** of varying depths can maximize space when storing flatware, cooking utensils, dishcloths, bowls, plates, pots and pans.

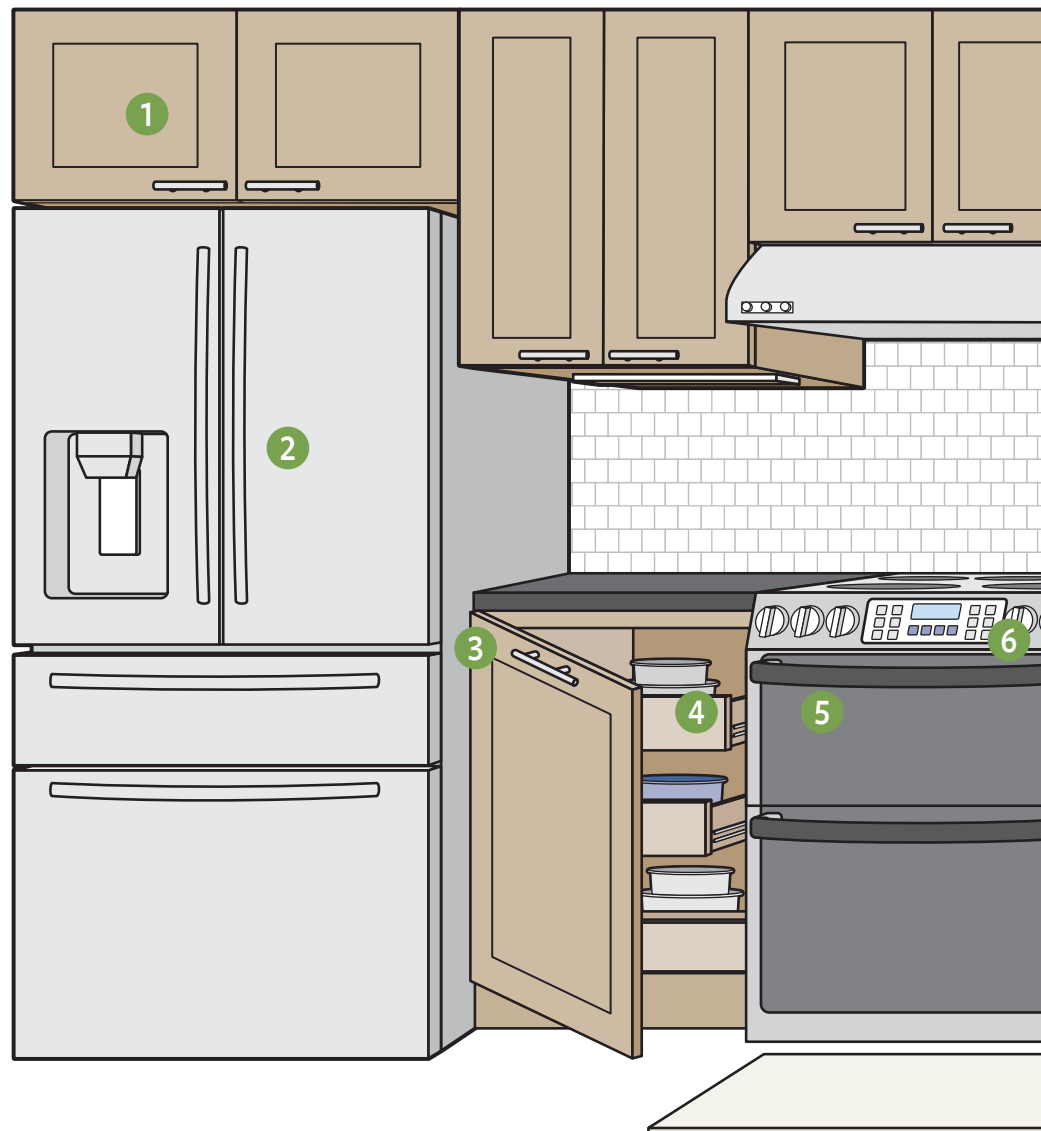

10. Ceiling lights illuminate the room. **Task lighting** is needed above the sink, stove and other work areas, such as along the countertop or over a kitchen island. If hardwired lighting isn't available — or if very direct lighting is needed — a plug-in desk lamp can be an option. (An example appears on the next page.)

11. A lever-style, light-touch or sensor **faucet** is both easier to use and more sanitary than one with turn-style knobs or handles.

12. A **hot water dispenser** is very useful for tea drinkers — or anyone who doesn't want to wait for water to boil.

13. Pullout pails beneath the sink keep **trash and recyclables** out of the way and out of sight. If the sink doesn't have a garbage disposal, a small bucket can be placed nearby for collecting and then composting food scraps.

14. Drawer-style appliances — such as the pictured refrigerator, range and double-drawer **dishwasher** — are more expensive than single-door swing-open models. But the ease of use and energy savings (gained by not having to operate or open the entire appliance at once) can be worth the cost. A single-drawer dishwasher could be suitable for a small kitchen or small household.

15. While an over-the-range microwave oven is an efficient use of space — one with the added benefit of providing an exhaust fan and lighting — the placement can cause problems. Lifting and lowering heavy and often hot cookware is difficult and dangerous. A **countertop microwave oven** or one built-in at that height is safer and easier to access. A safety note: A countertop microwave needs at least 3 inches of clearance along its top and sides and a minimum 1 inch of clearance in the back. Also, the appliance must be located at least 2 feet from a stove or else installed using a built-in kit from the manufacturer.

Continued ▶

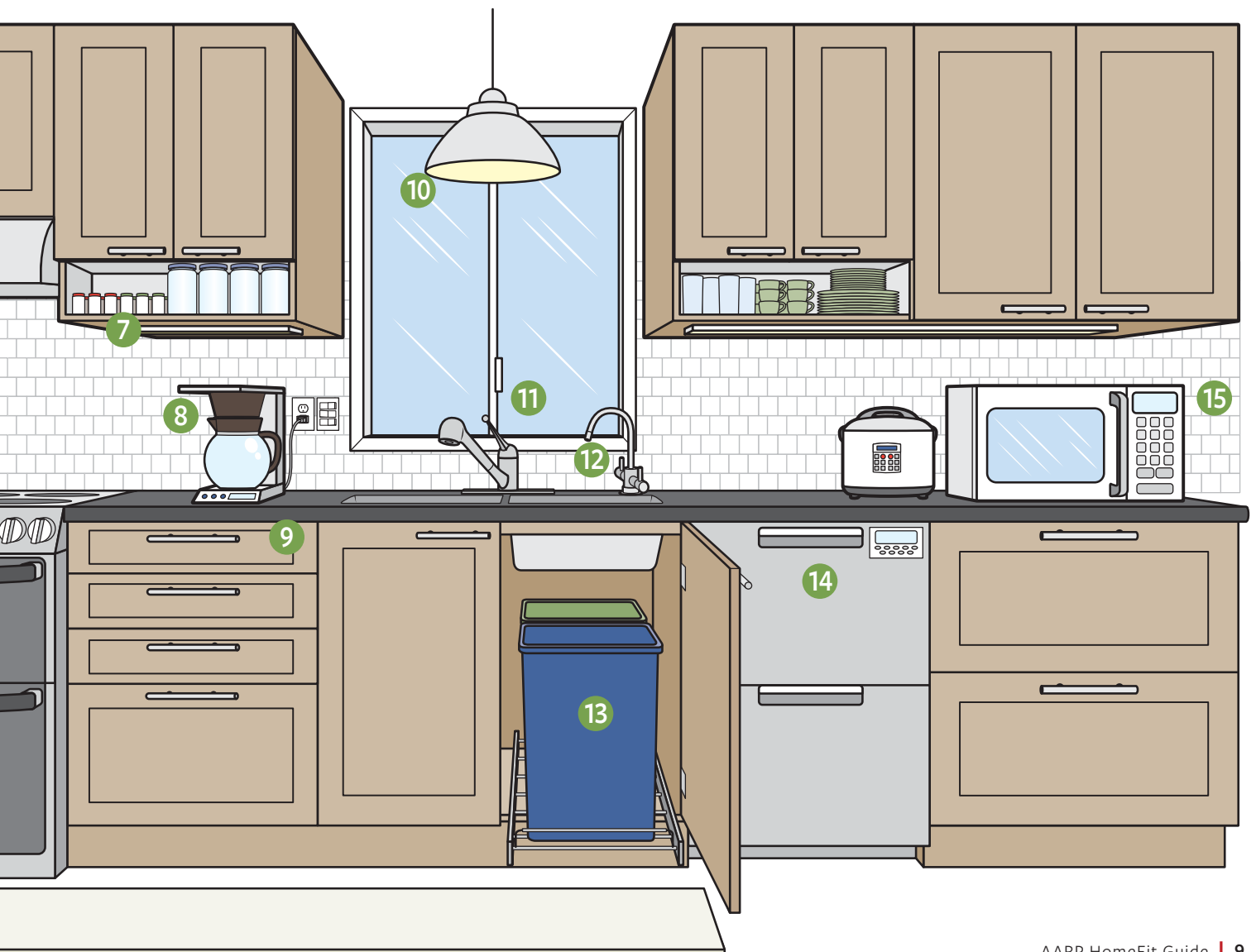

The Kitchen *Continued*

Storage

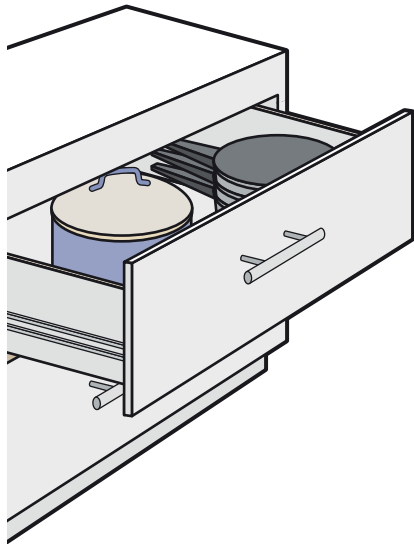

- Storing **pots and pans** in drawers or on open shelves rather than in cabinets makes cookware easier to locate and is friendlier to backs and knees. (No more bending, stooping or stretching while searching for a skillet or digging it out from the back of a deep, dark cabinet.)
- Adding a **turntable** to a corner cabinet can make pots, bowls and other items more accessible.
- If **medications** are stored in the kitchen, keep them away from any heat source. If small children live in or visit the home, keep medicines (as well as cleaning products and other toxins) out of reach or in a locked space.
- If the kitchen has a walk-in **pantry**, ensure that the space is well-lighted and has adjustable shelving to accommodate varied content heights. Protect against tripping by not using the floor for storage.

- If a **step stool** is needed for reaching higher shelves, select one that has grip handles and nonslip surfaces. (See examples on pages 21 and 25.) Another option is to use a “reacher” or “grabber” stick, which allows a user to stand at floor-level while retrieving items from an otherwise inaccessible spot.
- Although wall cabinets typically come with just one or two shelves, **extra shelves** are often available from the manufacturer or a home improvement store. Added shelving can allow mugs, bowls, glasses and stacks of plates to be stored without wasting vertical space (see below). Another benefit: When the lower portion of a wall cabinet provides two or three levels of storage, more items can be kept within easy reach. The very high shelves can store extra or infrequently used dishes.

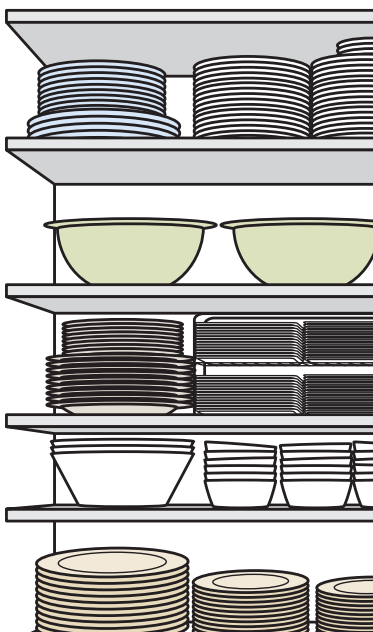

Work Spaces

- It's helpful to have a spot in the kitchen where household paperwork or cooking **tasks can be done while seated**. The work surface can be a table, multilevel countertop or pullout platform. Another option is to remove a lower cabinet so the counter space above it can be used as a desk. (See below.)
- When a countertop and floor are the same or similar colors, it can be hard for people with a vision impairment to distinguish between the edge of a counter and the floor below. **Contrasting colors or patterns** — or even a piece of brightly colored duct tape placed along the counter's edge — can differentiate the surfaces.
- A polished floor can be slippery, and a wood or tile floor can be tough to stand on for long periods. Placing **cushioned, slip-resistant floor mats** by the sink and stove can improve safety and comfort. (See the long mat on the previous page.)

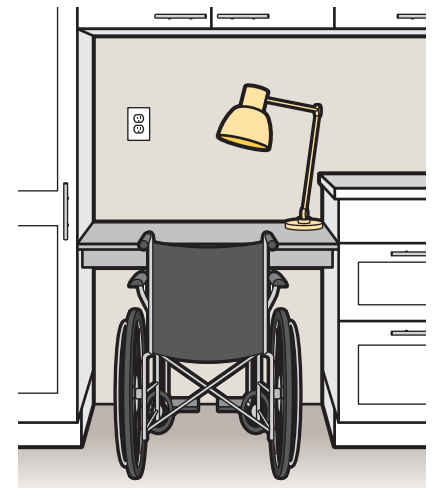

The Dining Area

There was a time when most meals were served and eaten at a kitchen or dining room table. Nowadays, both quick bites and full meals are often eaten on the go or at a kitchen island or in front of a television or computer. As a result, many rooms are now dining rooms.

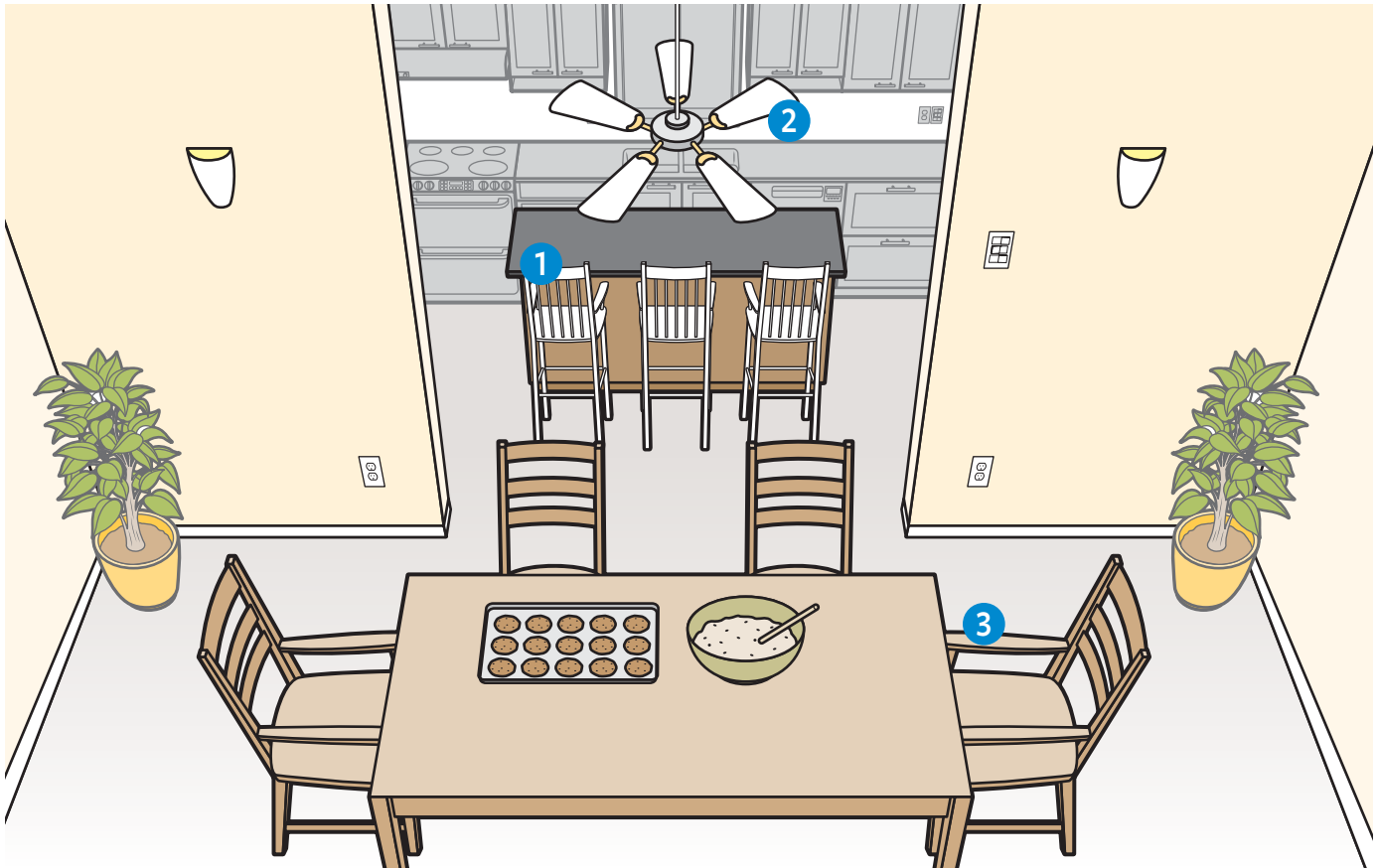

FOLLOW THE NUMBERS

1. When a **kitchen island or countertop** serves as a spot for eating, working on a laptop computer or simply hanging out, select seating that's sturdy and safe for all potential users. Since a countertop is usually taller than a typical tabletop, barstools are a common seating choice. Stools with a seat-back, armrests and solid, widely spaced legs are a more stable choice than styles without those features.

2. If the breeze from a **ceiling fan** in a kitchen or dining area extinguishes the flames when cooking on a gas range, cools plates of hot food or sends lightweight items flying, toggle the fan's direction switch so the blades rotate in a clockwise direction. (See page 30 for more about ceiling fans.)

3. Dining table **chairs with armrests** provide support for getting into or up from the seat.

Takeout Trays

If a meal will be eaten elsewhere in the home — in front of a TV, for instance — use lightweight **servicing trays** to transport plates, drinks and utensils instead of carrying each item by hand. (Tip: Trays are available for attaching to a walker or wheelchair.) Another option is to use a **divided dinner tray** with compartments for an entrée, some sides, utensils and a beverage.

The Living Room

Like the dining room, the living room in most American homes has become more casual, serving as a family or TV room rather than a rarely used, off-limits space for entertaining guests.

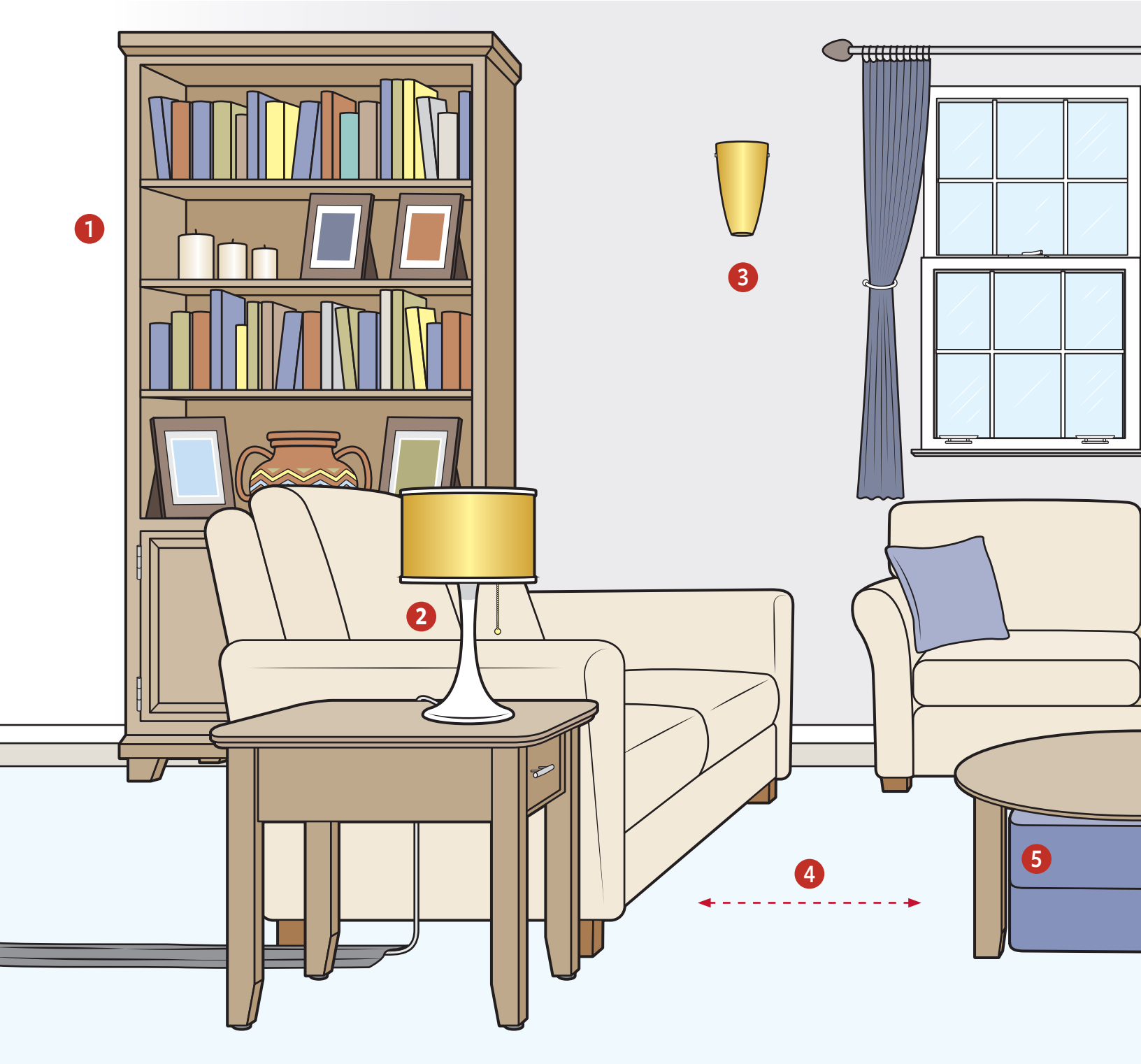

FOLLOW THE NUMBERS

1. To prevent tipping, **tall furnishings** — such as a bookcase or breakfront — should be anchored to a wall by using furniture safety straps or brackets.

2. When lamps or plugged-in electronics sit on furnishings that aren't flush to a wall, the **exposed cords** should be secured to the floor or a piece of furniture by using an electrical-cord-approved adhesive or covering. Check the cord regularly to ensure there's no fraying or breakages.

3. Hardwired ceiling fixtures and **wall sconces** provide lighting without cords.

4. If someone in the home uses a walker or a rollator (which is a walker with wheels), provide about 2 feet of **clear space** between a coffee table and the couch so the person has room to maneuver while sitting down and getting up.

5. It's nice and sometimes necessary to sit with one's feet elevated. Keep an **ottoman or footrest** nearby — but out of the way (such as beneath a coffee table) when not in use.

6. Avoid choosing furniture with **sharp corners**, which are bumping, bruising and cutting hazards for people of every age.

7. Window treatments in the living room or anywhere in the home should be easily accessible for opening, closing and cleaning. Secure the curtain and blind cords so no one becomes tangled in them and trips.

8. Secure **area rugs** to the floor with nonslip mats or double-sided tape, which will also keep the edges from curling up. (Note: The folded carpet corner shown below and elsewhere in the guide is for demonstrating the use of tape and is *not* a decorating tip or safety solution.)

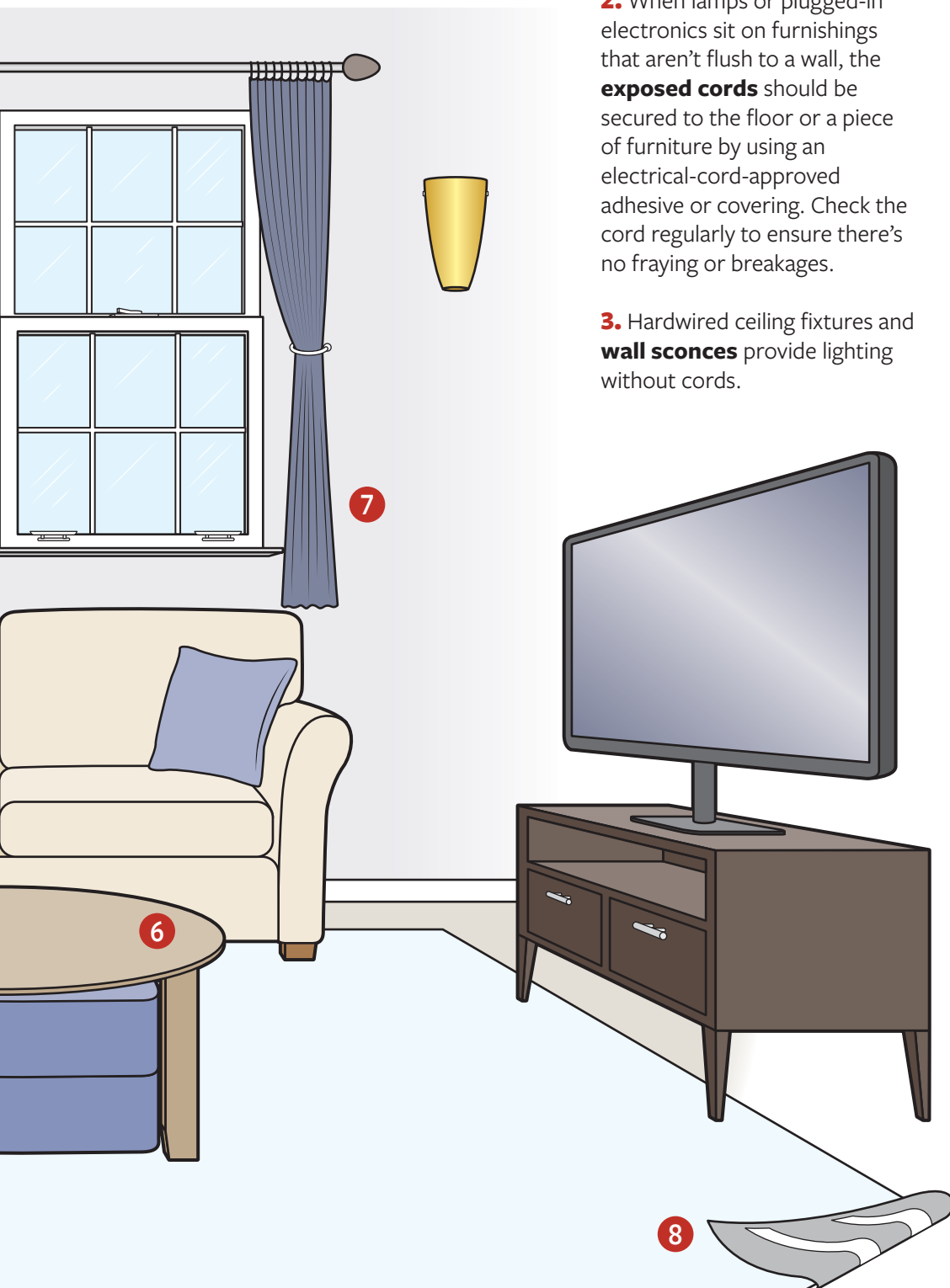

Continued ►

The Living Room *Continued*

TV Guides

Watching television is complicated. TVs come in numerous styles and sizes and offer a dizzying array of functions and “smart” features.

Models with names that include one of an expanding list of acronyms — HDTV, HDR, LCD, UHD, DLP, OLED, QLED — or other designations such as 4K or 8K are all high-definition televisions with either a curved or flat screen. These televisions typically weigh less than the older, deeper, bulkier cathode-ray tube (also called picture tube) TVs that were the norm until the early 2000s. The choice of shows, series, networks and delivery methods (cable, Direct TV, internet TV and, yes, those original antenna-access channels) is similarly complex.

Select the correctly sized set for a specific space

Old-style televisions need to sit on furniture or, in some cases, are as big as a large piece of furniture.

Flat-screen televisions can sit on a piece of furniture (as shown on the previous page) or be mounted on a wall, much like a mirror or large artwork. Such installations should be done by professional installers.

When choosing a location to hang or place a new television, select a spot where — if it falls due to a bad installation or, in some regions, an earthquake — there will be minimal risk of it hurting a person or pet.

One way to determine what size television is best for a space is to divide the viewing distance in inches by two. The result is the recommended size.

For instance, if a TV will be located 10 feet from a couch, that’s a distance of 120 inches. Divided by two, that’s 60 inches. So a 60-inch television (the diagonal measurement of the screen) would work.

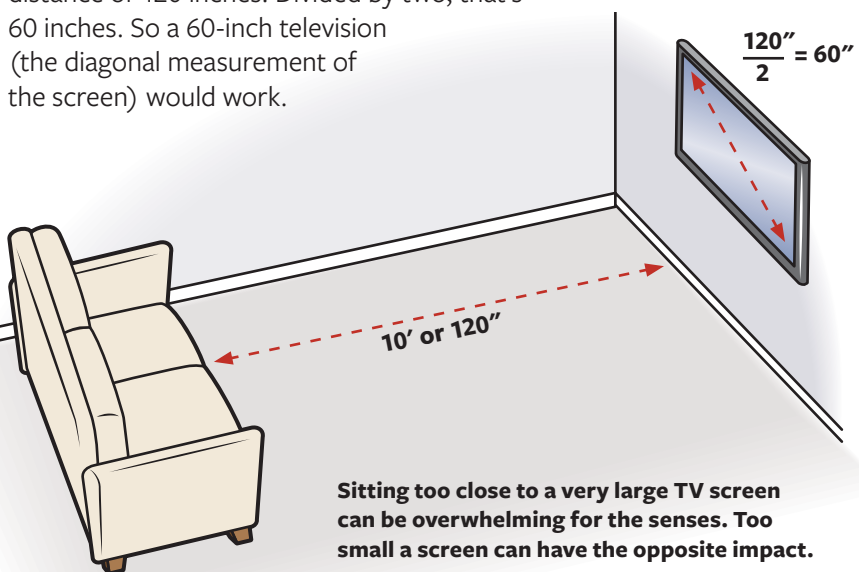

Virtual Assistants

Home-based automation systems and products (think Google Home or the Alexa-equipped Amazon Echo smart speakers) are able to provide real-time information and perform home-based tasks with little more than an internet connection and a voice command. The systems can, among other tasks:

- turn a TV on and off
- tune to specific shows
- play music and podcasts
- tell stories and jokes
- lead games
- control lights and appliances
- do online research
- adjust thermostats
- lock and unlock doors
- make shopping lists
- place telephone calls
- provide reminders

But convenience comes with concerns.

In order to both meet and anticipate needs, data is collected by the devices, as well as by the internet service providers, internet browsers, and the websites a user visits.

Having at-the-ready information can be helpful to a user, but it can also be worrisome. When considering or using internet-connected automation systems, it’s important to consider the privacy pros and cons.

Tip: If a home’s internet network isn’t already password protected, instructions and the settings for adding security can be found on the service provider’s website or by calling customer service.

Lights On, Lights Off

- The ideal **height for light switches** is 36 to 44 inches from the floor.
- Since it's tough to turn lights on and off when one's hands are full, or impaired by arthritis or an injury, a **rocker-style “push” switch** (shown) is a more practical option than the small toggle on a traditional up-and-down flip switch. A rocker switch can be turned on or off by leaning against it, nudging it with an elbow or pressing it with whatever is being carried.
- **Electrical outlets** are best placed 18 to 24 inches above the floor unless needed at another height for a specific reason, such as to power appliances and personal electronics in a kitchen or home office, or to better serve a mobility or accessibility need.
- Connecting table lamps or other plug-in lighting fixtures to an **automatic timer** will ensure that lights are turned on and off at set times so no one has to walk into a dark room — and the home won't look unoccupied even if it is.
- Touch control or **pull-chain lamps** and on-off “clapper” devices are helpful for people who have trouble turning small knobs.
- **Dimmer switches** allow a user to adjust a fixture's lighting level as needed. They're sold as hardwired wall switches as well as corded options that work with lamps and other plug-in lights.

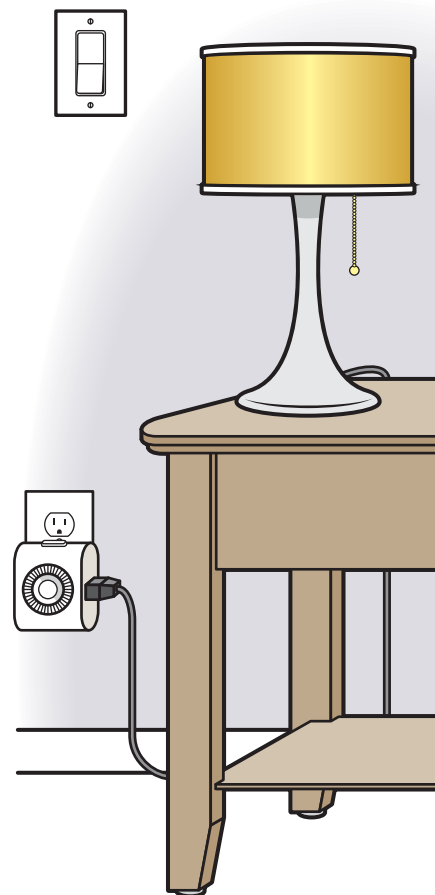

A Bit About Bulbs

Light bulbs come in a range of shapes, sizes and brightness levels. Choosing the right bulbs can make a home safer and a space more useful and enjoyable. These are the most common types for homes:

- incandescent
- fluorescent
- compact fluorescent lamps (CFL)
- halogen
- light-emitting diode (LED)

CFL and LED bulbs are energy-efficient and super long-lasting — up to 20 years. Using them reduces

the need to climb a ladder to replace burned-out, hard-to-reach bulbs. Fluorescent, halogen and traditional incandescent light bulbs range in energy efficiency from highest to lowest in that order.

Viewing a light bulb demonstration display at a hardware or home improvement store is a good way to choose what “color” bulb to use. For instance, warm white or soft white light bulbs provide a less harsh light than cool white or daylight white bulbs, which emit a brighter, bluer tone.

A few more things to keep in mind:

- Frosted bulbs result in less glare than clear bulbs.
- Using a bulb wattage higher than the rating indicated on the light fixture is a safety hazard.
- While dimmer switches and timers will work for any properly rated halogen or incandescent bulb, the same isn't true for all fluorescent, CFL or LED bulbs. Read the light bulb packaging to ensure compatibility.

Hallways and Stairways

A dark hallway can lead to unwelcome bumps in the night, the result of banging into furniture or tripping over random items left on the floor. Proper lighting, handrails and an absence of clutter can make halls, staircases and other passageways safe for all residents.

FOLLOW THE NUMBERS

1. Homes are often built with just one handrail along a staircase. But **two handrails** — one on each side — are a safer and more helpful configuration.

2. Stairway and hallway lights need to have **on and off switches** at both ends of the hall and at the top and bottom of the stairs. Light switches that glow in the dark are especially helpful in those areas. (An electrician is required for these installations.)

3. Placing plug-in or battery operated dusk-to-dawn or motion-sensor **night-lights** in hallways and near steps and staircases is a simple safety solution. When deciding where and how many night-lights to install, think of these low-wattage fixtures as lights for a residential runway.

4. The **safest surface and covering for steps** is a tightly woven, low-pile carpet with thin padding. If someone in the home has a vision impairment, visual or sensory cues (such as a front edge that has a different color or texture) can help distinguish each step from the tread of the next.

5. Uncarpeted steps are safest when they have a **nonslip surface**, such as adhesive strips or securely placed rubber stair treads.

6. Sinking **protruding nails and screws** will make steps safer, stronger and sometimes less squeaky. Steps with open backs should be closed with risers.

7. Don't leave anything meant to be carried up or down the stairs *on* the stairs. Collect the items nearby and carry them in a **tote or basket** that can be held with one hand so the other can grip the handrail.

8. As noted in the box on page 5, a bolt-style lock secures a door. Adding a **chain lock** allows a person inside the home to partially open the door in order to speak with someone on the other side while still maintaining safety.

9. If a **hallway electrical outlet** isn't being used, plug in a night-light to brighten the path.

Get a Lift

When single-story living is needed but not possible, a **stair chairlift** can be a practical and safe mobility solution. A **home elevator**, increasingly available at a variety of price points, is another potential solution.

To fit an elevator into a home, one option is to convert stacked closets (e.g. one on the first floor, the other above or below it) into an elevator shaft. A shaft can also be attached to the exterior of a house and situated so the elevator doors open into the residence. Other tips:

- If a new home is being built, it's smart to include a pair of stacked closets so an elevator can be installed at a later time if necessary.
- Another new construction solution is to build staircases so they're 42 inches wide. That allows two people to use the stairs while walking side by side, as might happen when one person is needed to help the other manage the steps.
- Installing electrical outlets at the top and bottom of a staircase during a home's construction will reduce the cost and complications of adding a motorized chairlift in the future, if one is ever needed.
- Stair chairlifts can be purchased used, which greatly reduces the price.

Home elevators and stair chairlifts aren't inexpensive, but they can be a better and more affordable choice than relocating. Each option costs much less than moving into an independent- or assisted-living facility.

10. When placing **furniture** in a hallway, maintain at least 36 inches of passing space so people can use the corridor without knocking into or being blocked by furnishings.

11. If a **carpet runner** is used in the hallway, secure it with a nonslip mat or carpet tape.

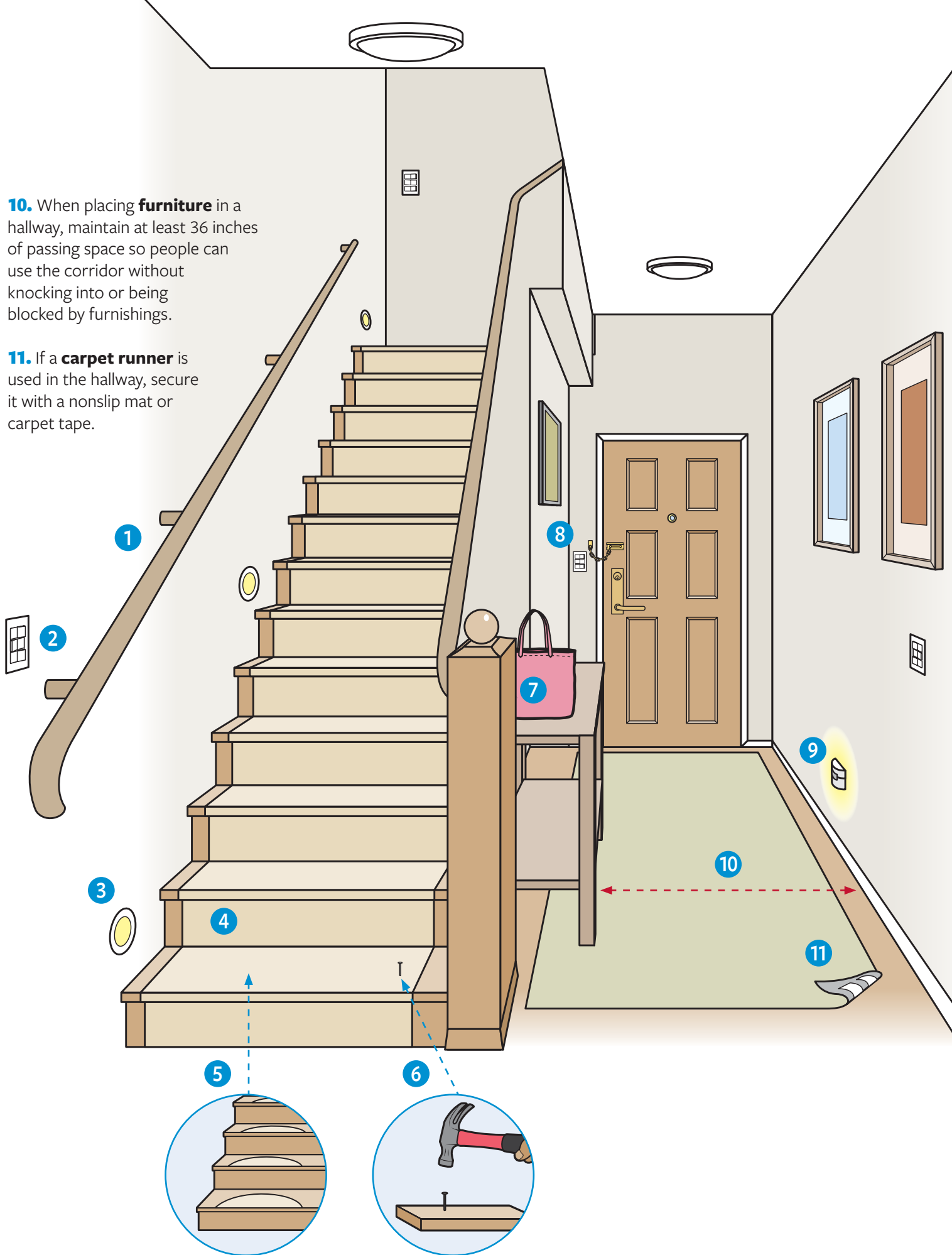

The Bedroom

With so many portable and high-tech devices at our disposal, the bedroom has become more than just a bedroom. Smartphones, laptop computers, exercise gear and game consoles often make their way into it. While the devices and their accessories are typically visible during daylight hours, they can pose serious tripping hazards in the dark — especially if the charging cords and items are left on the floor.

FOLLOW THE NUMBERS

1. A **light switch** near the doorway should turn on a ceiling fixture so the room can be lighted when anyone enters. If the room doesn't have a ceiling fixture, the switch can instead power a wall outlet into which a lamp is plugged. The downside of that setup: The light will only work when both the lamp and the wall switch are in the on position.

2. Create a **designated spot** — such as a basket, dresser top, drawer or nightstand — for storing any electronics, charging cords or computer accessories that end up in the bedroom.

3. Ensure that **tall furniture** is either secured to the wall or is stable enough not to tip over. (If the home is in an earthquake zone, wall hangings and tall furniture should not be placed near a bed.)

4. **Windows** need screens so fresh air can come in while bugs stay out. Windows should be able to open if needed as an emergency exit.

5. A **motion-sensor night-light** aids visibility when anyone walks to or from the bathroom when it's dark. Another option is to place a motion- or voice-activated light fixture in the room.

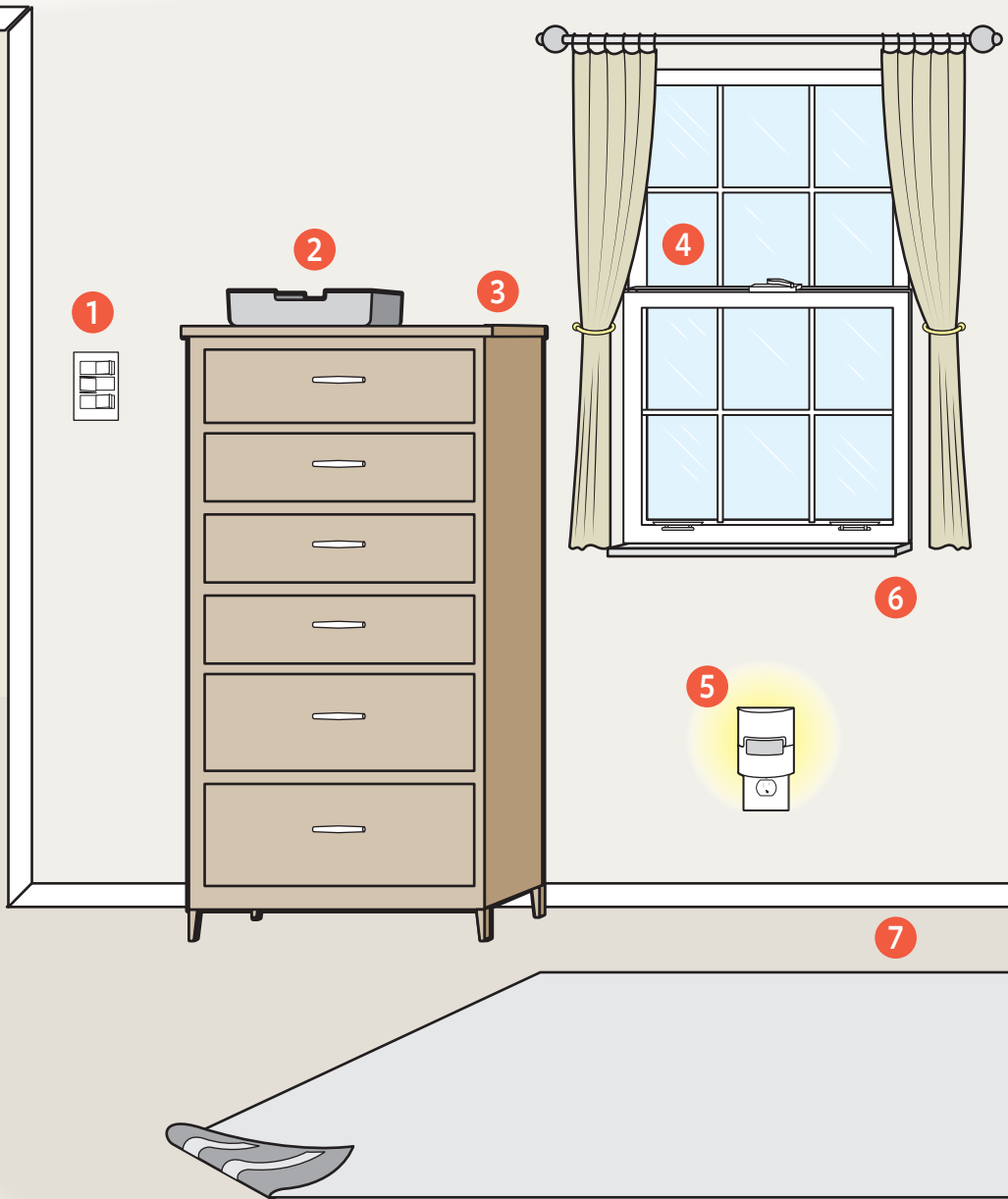

6. Let **natural light** in by keeping curtains, blinds or shades open during the day.

7. If **area rugs** are used, be sure they're secured to the floor with a nonslip mat or anti-slip rug tape.

8. If there isn't enough room on a bedside table for a lamp as well as all the other items that end up in the spot, consider hanging a **wall sconce light fixture** with an adjustable arm. The lighting can be hardwired or corded. Attaching adhesive clips or a cord cover to the wall will keep the electrical cord taut and out of the way.

9. If the bedroom doesn't have a landline **telephone**, a cell phone should be brought into the room each night. (Invest in an extra charger so there's always one plugged in and ready.)

10. Positioning a bed so one side is flush to the wall means it will be hard to make on a daily basis — and even harder to manage when changing the sheets. Placing the **bed so both sides are accessible** is a more practical solution.

11. A **digital clock** with large, lighted numbers will make the time visible from distances and at night without the need to put on glasses or turn on a light.

12. Power outages happen. Keep a working **flashlight** near the bed or else know how to use a smartphone flashlight.

13. Carbon monoxide (CO) is a deadly, colorless and odorless byproduct of burning carbon fuels, such as natural gas, propane, wood, heating oil or gasoline. Any home with a fuel-burning appliance, fireplace or attached garage needs at least one **carbon monoxide detector** on every level — and especially in or near the bedrooms. The detectors (also called monitors or alarms) are siren-equipped and come in battery-powered, plug-in and hardwired versions. CO detectors are most effective when placed 5 feet from the ground or a few feet below the ceiling.

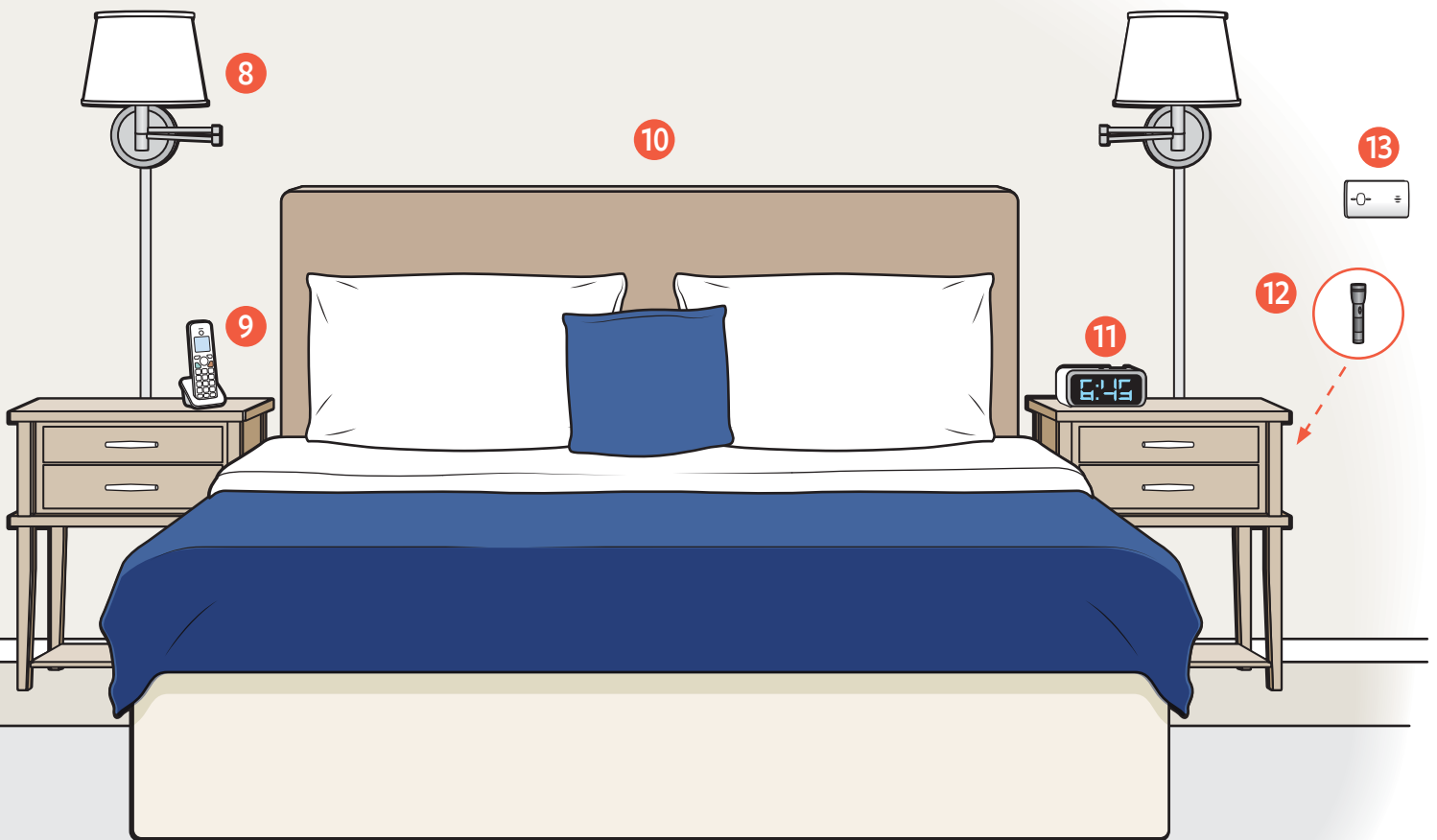

Closets

Clothes closets, linen closets, coat closets and pantries work best when set up for the specific purpose each serves. Having organized, uncluttered closets makes it easier to find belongings, helps save money by averting duplicate purchases, and eliminates the need to dig through overstuffed spaces and the risk of injury from falling items.

FOLLOW THE NUMBERS

1. It's helpful to have a place to sit while dressing, especially when putting on pants, socks or stockings, and shoes. A **chair** can be placed next to or near a wall closet or inside a walk-in closet.

2. A light outside of the closet can be directed to shine into the space. A **recessed ceiling light** can become a spotlight by replacing the fixture's standard trim with an adjustable eyeball-style trim. (The same solution can work for lighting near stairs, as well as in kitchens, hallways and many other spaces.)

3. If a **closet light** isn't already hardwired into or near the space, it's easy to install a peel-and-stick, battery-operated fixture. Some closet lighting solutions feature a sensor that turns the light on or off as the door is opened or closed.

4. Most closets have a single clothing rod, usually placed around head height, which works well for hanging dresses or coats. If the closet is used for skirts or shirts, or pants that are folded over a hanger, consider a **double clothing rod** set-up instead.

5. Use bins to prevent items stored on the **closet floor** from becoming a messy pile or spreading beyond the space.

6. **Adjustable shelving** provides options for storing folded clothing or bed linens. Bins can hold socks and undergarments. High shelves can be used for seasonal items, such as a cold weather comforter.

7. The lower portion of a closet can be reserved for **shelves and wire bins**, built-in drawers, or a piece of furniture, such as a dresser.

8. A flexible, **lightweight basket with handles** makes it easier to carry clothing to and from the laundry area.

9. Keep a sturdy, nonslip **stepladder** with handgrips nearby for reaching items on high shelves or clothing rods. A snazzier solution: Install a mechanized closet system that, with the push of a button, lowers and extends shelves and clothing rods.

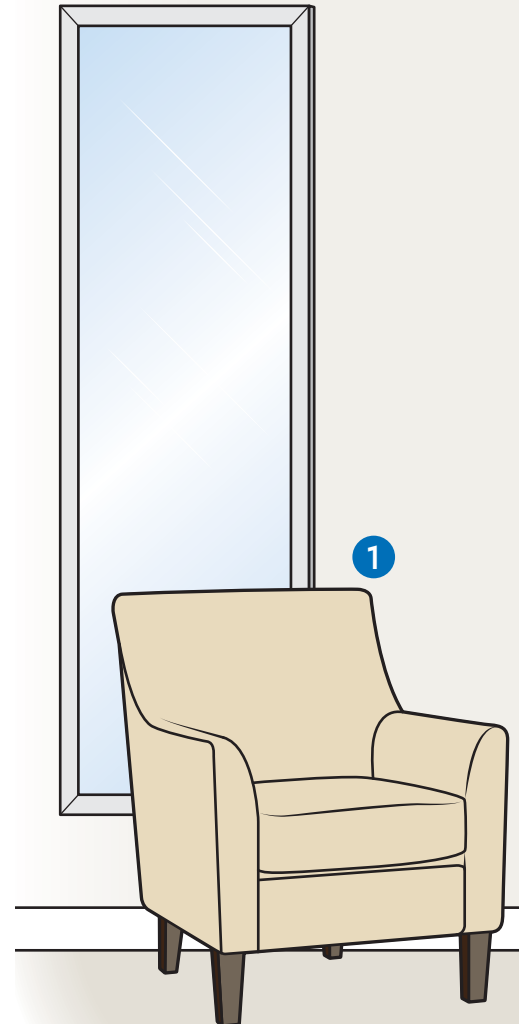

Cutting the Clutter

Organizing and consolidating belongings can be a physically and emotionally daunting task.

Recruiting family and friends to help is one solution. Or a professional organizer can be hired to guide or do the work.

The AARP webinar *Downsizing and Decluttering: You Can't Take It With You!* includes these tips:

- **Set a Timer:** Select a 2-foot by 2-foot spot in a room and spend 10 minutes — not more, not less — focused on decluttering.



- **Sort:** Create four piles — *Keep*, *Sell*, *Donate* and *Trash* — and divide the items accordingly. (Place the *Keep* pile the farthest away so it's the least convenient.)

- **Purge the Papers:** Run unneeded mail and documents through a shredder.

- **Don't Punt:** Punting is a form of decluttering by guilt-tripping others, especially younger family members, into taking the purged possessions.

- **Get Real:** Don't continue keeping clothes that don't fit, haven't fit for years and are unlikely to ever be worn again.

- **Pare Down the Pictures:** Select a quantity of printed photographs (say, 100 or 200) that are worth keeping. Write captions on the back of each. Discard or digitize whatever doesn't make the cut.

The Bathroom

Sometimes, more attention is paid to how a bathroom is decorated than to the safety of the space. Water on a bathroom floor is a slipping hazard, and often an invisible one. Falling in a bathroom is painful and potentially life-threatening because of the many hard surfaces — the floor, toilet, countertop, tub.

FOLLOW THE NUMBERS

1. A **comfort-height toilet** is taller (17 to 19 inches from the floor to the seat top) and, depending on a person's height, often easier to sit down on and get up from than a standard 15-inch version.

2. A **bidet** is a personal hygiene device for cleaning one's bottom. Sometimes recommended for health reasons, it can also be a way to reduce toilet paper use. For many people, the use of a bidet is a personal preference or cultural norm. Traditional bidets were basins installed next to a toilet. Modern versions come preinstalled into toilet seats or as an attachment for them. (Many are available for under \$100 and easily tap into the toilet's water supply piping.)

3. Some manufacturers make bathroom accessories that serve dual purposes. For instance, this toilet paper holder is also a **grab bar**. (Learn more below.)

4. **Wheelchair users** need a minimum 5 feet of open space to maneuver into and turn around in a room. A standard 32-inch wall-mounted or open-base sink is usually usable from a wheelchair. **TIP:** A sink that's set within a vanity base can be made wheelchair accessible by opening or taking off the door(s) and removing the cabinet's toe kick and floor.

5. Bathroom **shelves** can keep a small supply of towels and toiletries nearby.

6. A **motion-sensor night-light** provides safety lighting.

7. A 36-inch-high **sink base and vanity** requires less bending for someone using the sink.

8. Lever-style sink, shower and tub **faucets** are easier to use than ones with knobs or handles.



Take This Bar Exam

QUESTION: Is a towel bar the same as a grab bar?

ANSWER: Usually no.

A grab bar, sometimes called an assist bar, is secured to a surface that's backed by a wooden stud. That way, the bar won't detach if gripped for support by someone climbing into and out of a tub or shower — or grabbed in an effort to prevent a fall. (Suction-cup grab bars and handles are *not* suitable substitutes.)

Grab bars should be installed near the tub, shower and toilet. A slightly textured, nonslip surface is safest. A horizontal placement helps a bather move forward and backward in a tub. A diagonal installation is useful for getting into a seated or standing position.

If there isn't room for both a towel bar and a grab bar, opt for the grab bar (and hang a towel on it). Grab bars are increasingly available in decorative, dual-purpose styles.

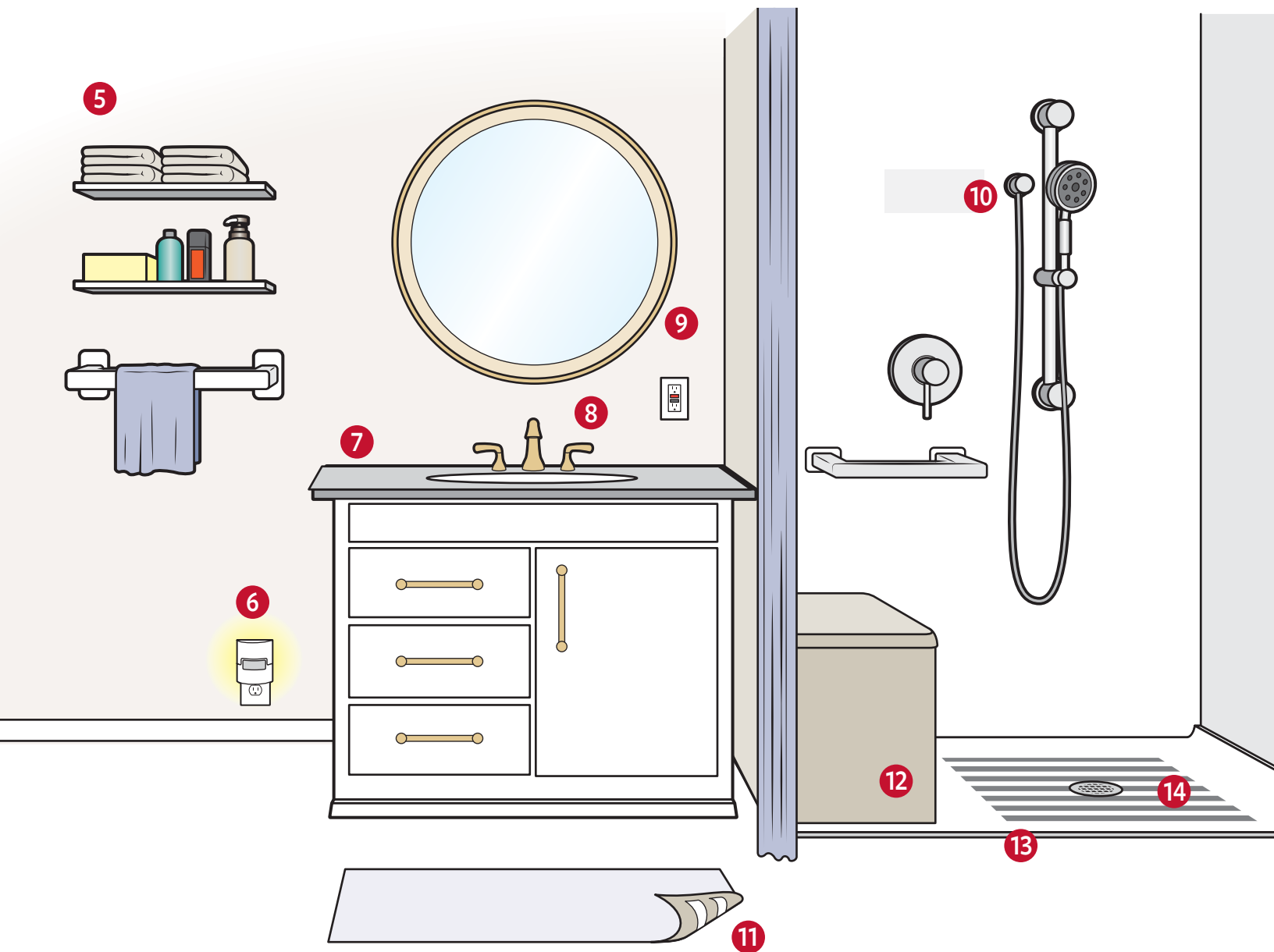

9. Electrical outlets near water need to be equipped with a **GFCI** (ground fault circuit interrupter).

10. An adjustable-height, handheld **showerhead** makes the shower customizable for users of different heights and abilities.

11. Bathroom **rugs or mats** should be rubber-backed or secured with rug tape or a rubberized under-carpet mesh.

12. Permanent or portable **shower seating** is a relaxing safety feature.

13. A wide, **doorless shower** with a **no-step entry** is accessible for all, including wheelchair users and others with a disability or anyone who needs another person's assistance. (Such barrier-free showers are increasingly common in high-end hotels.) Similarly suitable options include full-swing shower doors or the use of a shower curtain or partial wall to cover the opening.

14. To prevent slipping, the shower floor and bathtub bottom can be covered with **nonskid mats** or lined with several **nonslip strips**.

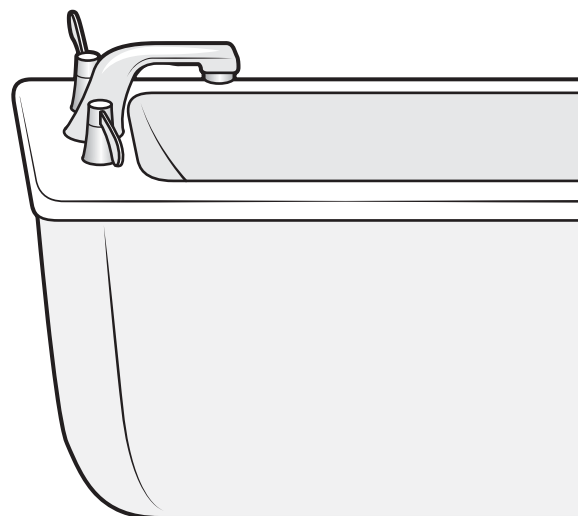

The Laundry Area

The best location for a laundry room or area is near the rooms where clothing is put on and taken off. In most homes, especially older ones, that's not possible.

In fact, in many older homes, the laundry "room" is little more than a washer and dryer in a corner of the basement. Since even one load of wash can require multiple trips up and down one or more flights of stairs (often while carrying a hard-to-manage basket), laundry day brings with it the risk of trips, falls and muscle strains.

Doing laundry in an apartment complex's laundry room or at a laundromat several blocks or miles away requires taking dirty clothes and linens on a journey. Investing in a laundry basket with wheels (as shown in the illustration) or using a foldable shopping cart is a better and safer option than hoisting heavy bags or baskets and carrying them to and fro.

Using a laundry service that offers pickup and delivery can be a helpful solution when doing laundry becomes too difficult or time-consuming (or both).

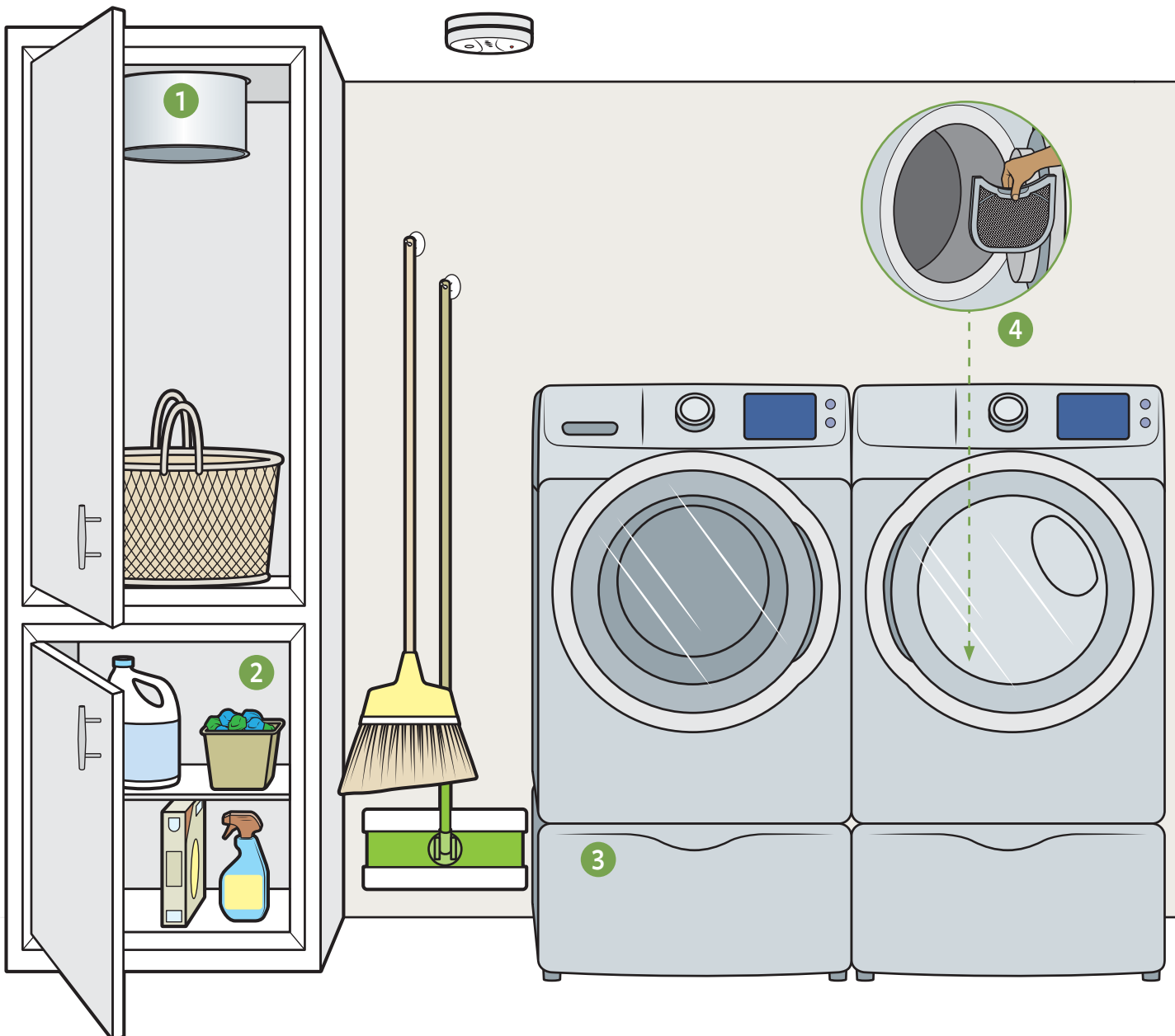

FOLLOW THE NUMBERS

1. If the washer and dryer can't be relocated out of the basement, a **laundry chute**, through which dirty clothing, bath towels and bed linens are dropped from an upper floor to a spot near the machines, may be an option. Another solution is to install a motorized stair chair lift (see the box on page 16) along the staircase.

2. Detergent and bleach containers can be heavy. Store them in a **cabinet**, on a table or on a shelf that's properly secured to the wall so they're easy to reach and lift. If lifting is difficult, consider using detergent pods, which are both lightweight and very portable.

3. When purchasing a new **washer or dryer**, consider the style options and which door placement (top or front) will be easiest to use. Stacked units save space, but can be difficult for some users to reach. If bending to load or empty a front-load washer or dryer is difficult, the units can be placed on a **platform**. (The models sold by appliance manufacturers often include storage drawers.)

4. Dryer lint can clog exhaust vents, undermine the effectiveness of the dryer and even cause a fire. Empty the **lint trap** before or after every use. See page 30 for important information about the dryer's exhaust vent ductwork.

6. If the home has an actual laundry room with adequate space, add a **table** so clean clothes can be sorted and folded on site. (In a multi-person household, each member can be tasked with carrying his or her own laundry to and from the room.)

7. A **wheeled laundry basket** can eliminate or reduce the need to lift heavy baskets. A flexible basket with handles that can be gripped with one hand (such as what's pictured beneath the laundry chute) is easier and safer to carry than a rigid basket that's awkward to hold and can block a person's view of where their feet are stepping.

8. If a **step stool** is needed for reaching a hanging rack, select one that's sturdy, won't slip and includes a grab bar. Other safety features for the space are a **smoke detector** (like the one shown on the ceiling) and, if there's a gas dryer, a carbon monoxide detector. See pages 19 and 26 for more about those.

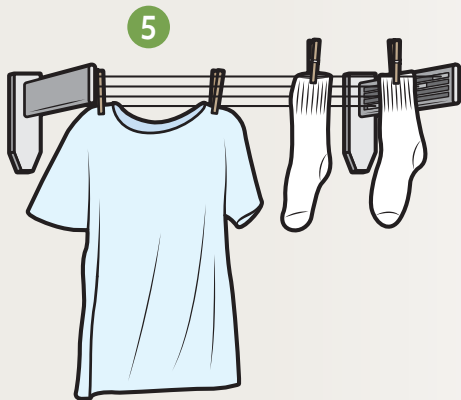

5. When using a clothesline or installed **drying rack**, be sure it's not located where someone might accidentally walk into it. A retractable line can be put away when not in use. If a safe hanging location isn't available, or if lifting items to hang them is difficult, use a drying rack that can sit on the floor.

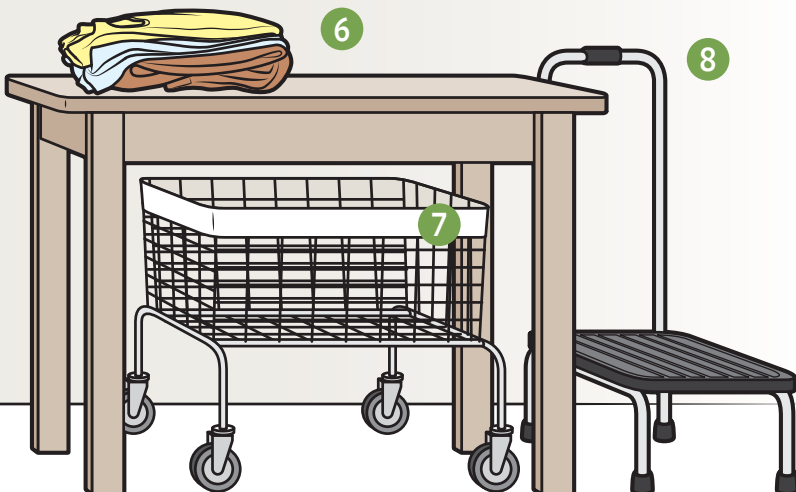

The Broom Closet

Not every home can have a dedicated closet space suited for this purpose, but it's handy to designate a section of a closet or an accessible but discreet spot for storing a mop, vacuum cleaner, dusting wand and, of course, a broom. Keeping cleaning equipment and supplies in one location means less searching for what's needed. Hooks can be used to hang most items. (See the examples next to the washer.) If wall space isn't available, a tall kitchen trash pail can be used to keep brooms and mops standing upright.

The Garage

In 2015, nearly 25 percent of new single-family homes had a garage that could hold three or more cars. In fact, according to the National Association of Home Builders, more three-car garages were built in the nation that year than one-bedroom apartments.

At the same time, the American Housing Survey reported that nearly 80 percent of owner-occupied

housing had a garage or carport. Two years earlier, a Home Innovation Research Labs survey found that “only about 70 percent of garage space in single-family homes is available for parking because the floor space is occupied by something other than a parked car.”

Home-based spaces that are used for parking cars or possessions need to be safe for people.

FOLLOW THE NUMBERS

1. Garage doors are heavy, and they can drop quickly if not carefully opened and closed. A professionally installed **automatic garage door opener** makes the door easier and safer to use. Sensors prevent the garage door from closing on anything in its path, including people and pets.

2. If a garage houses a vehicle *and* other items (a lawn mower, **trash receptacles**, bicycles), avoid placing things where they will prevent car doors from opening.

3. A home’s **electrical control panel** might be located in the garage or basement, or in a utility room or closet. Label the switches inside the panel box in case a circuit needs to be turned off or tested.

4. Yard tools can be tripping hazards when stored on the floor or simply leaned against a wall. **Storage racks and tool hangers** are good solutions and are available in many styles.

5. Garage door openers typically come with a light fixture that turns on when the remote control or wall switch is used to open the door. However, more light is needed in a garage than what an opener provides. Adding **motion-sensor lighting** can avert the need to wander around in the dark.

6. **Wall-mounted controls** for the garage door and overhead lights enable both to be turned on and off from the door to the house.

7. An uncluttered space near the interior door is a good spot for installing a wall-mounted **fire extinguisher**.

8. A small **table or workbench** is handy for placing packages that are being moved into or out of the home.

9. A garage should be equipped with a **smoke and fire detector**. A home with an attached garage needs a carbon monoxide detector inside the living space within 10 feet of the door to garage.

10. The door between a home and an attached garage should have a secure **door lock**. Garage doors are often left open or unlocked. Older opening systems often don’t have the security features newer models contain.

11. The wood or metal **threshold strip** on the floor of an entry doorframe primarily serves as a weather seal. Flat thresholds are friendlier to feet, wheelchairs and baby strollers than raised ones.

12. A disorganized garage can become a home to clutter and tripping hazards. **Storage bins and secure shelving** are useful additions.

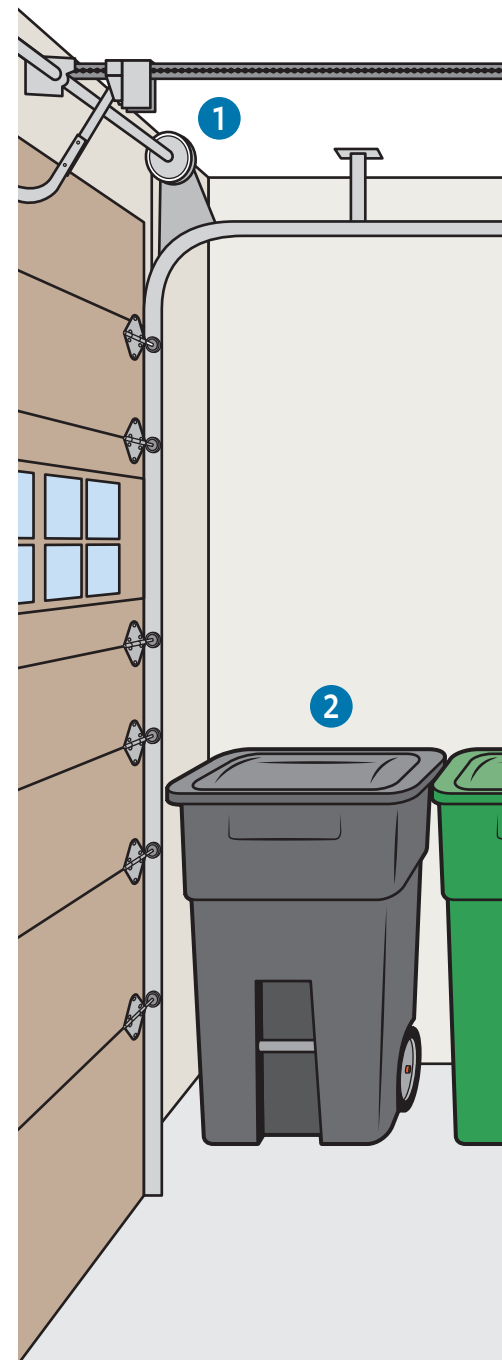

13. Driving too quickly or deep into a garage can have dangerous consequences. By marking where a driver entering a garage should stop, a **garage parking aid** can prevent injuries and damage. (The freestanding version shown here is among the many types available.) In a narrow or very tight garage, rubber molding strips can be installed along the side walls to prevent damage from opening car doors.

Trash Talk

Residents of single-family houses usually need to bring their trash to the curb. People residing in an apartment or mobile home typically carry their trash to a central location.

Trash bins come in many sizes and styles. Large bins with wheels work well for households that have outdoor or garage storage.

In an apartment, there usually isn't room for multiple or large bins, so the trash must be taken out frequently.

If the disposal location is far away, the trash bag and recyclables can be placed in a foldable, wheeled shopping cart for carrying to the community receptacles.

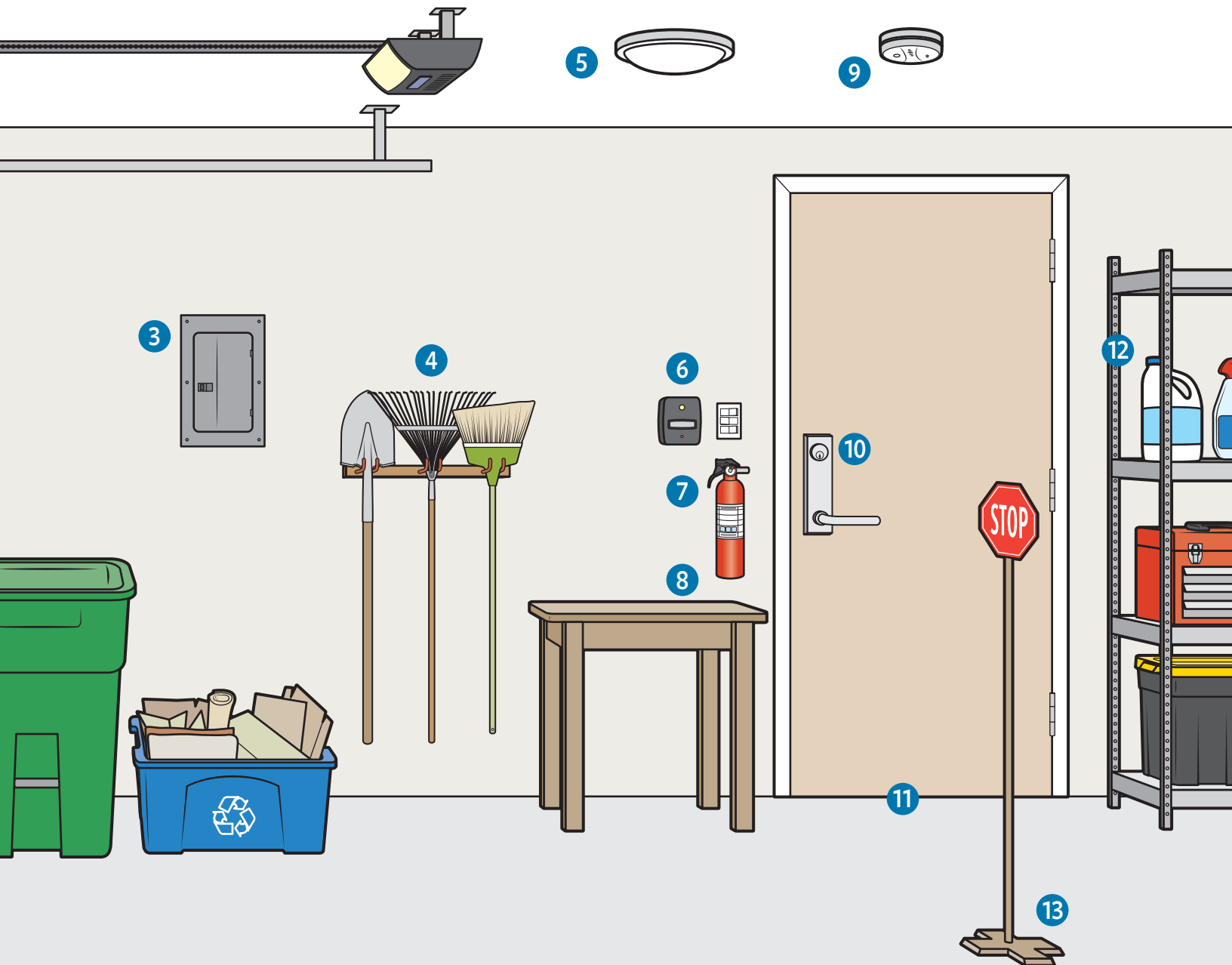

Outdoor Places and Shared Spaces

Caring for a home is work. Caring for a home with a yard is even more work. Freedom from lawn care, snow-shoveling, raking, weeding and mulching are among the many benefits of living in an apartment building, some town house developments or a full-service community.

Regardless of someone's owner or renter status, or the dwelling type, the concerns listed below apply. One difference is whether the necessary work must be either done or arranged by the resident, a non-occupying owner, a homeowners' association or a management company.

FOLLOW THE NUMBERS

1. An entrance **overhang or awning** provides needed shade from the sun and cover from rain.

2. People of all ages ride **bicycles**, so apartment buildings, community centers and locations in residential developments are well-advised to designate places where the bicycles of residents and guests can be stored or at least temporarily secured.

3. Placing a **bench** near an entrance allows someone who's expecting the arrival of a ride, a delivery or a child's school bus to sit while waiting.

4. Residents and passersby might leave litter on the ground if **trash receptacles** aren't readily available. Bins that separate paper and other recyclables from ordinary garbage can both help the environment and keep shared spaces clean.

5. If the property has steps, a pair of sturdy, easy to grip **handrails** are needed.

6. As noted on page 5, **entrance lighting** is a home safety must.

7. Outdoor furniture — placed on a porch, patio or lawn — can encourage people of all ages to enjoy good weather by spending time outside.

8. For the safety of all residents and guests, **exterior pathways** should be kept free of holes, loose bricks, uneven pavement, branches, leaves, moss, mold and other tripping and slipping hazards. The paths should be quickly cleared following snowfall or storms.

9. For both appearance and safety, a property's **landscaping** needs to be maintained, with the lawn mowed before it overgrows and shrubbery kept trimmed.

10. Pathway lighting enables residents and visitors to approach a house or apartment building safely after dark. The lighting also allows the people inside the home to see what's happening outside. Outdoor lighting fixtures can be equipped with timers or sensors to automatically turn the lights on at dusk and off at dawn and/or when movement is detected.

On- and Off-Ramps

An access ramp (like the one shown at right behind the chairs) can be permanently or temporarily added to a home or building that doesn't have a zero-step entry.

The Americans with Disabilities Act calls for a 5-degree incline or 1:12 slope. That means every inch of vertical rise requires 12 inches of horizontal length.

Since a three-step entrance, for instance, is about 22 inches high, a ramp would require a 22-foot horizontal length.

When an extended length of space isn't available, a ramp can be built with switchbacks. Each section ends at a landing where users turn and continue moving up or down until the end.

TIP: A home ramp doesn't need to be at the front door. It can lead to any suitable door, including one inside a garage, which provides the bonus of protection from inclement weather.

Tenant Rights

The legal rights and protections for residents who rent rather than own vary by both location and situation. For instance, the rights of tenants who rent from an individual or private company differ from those

who live in government-sponsored housing. The website of the U.S. Department of Housing and Urban Development provides links to resources for every state, Puerto Rico, the U.S. Virgin Islands and the District of Columbia. Visit HUD.gov

and enter the search term “tenant rights.” Information about the Fair Housing Act and the Americans with Disabilities Act can be found on the same website by searching the phrase “disability overview.”

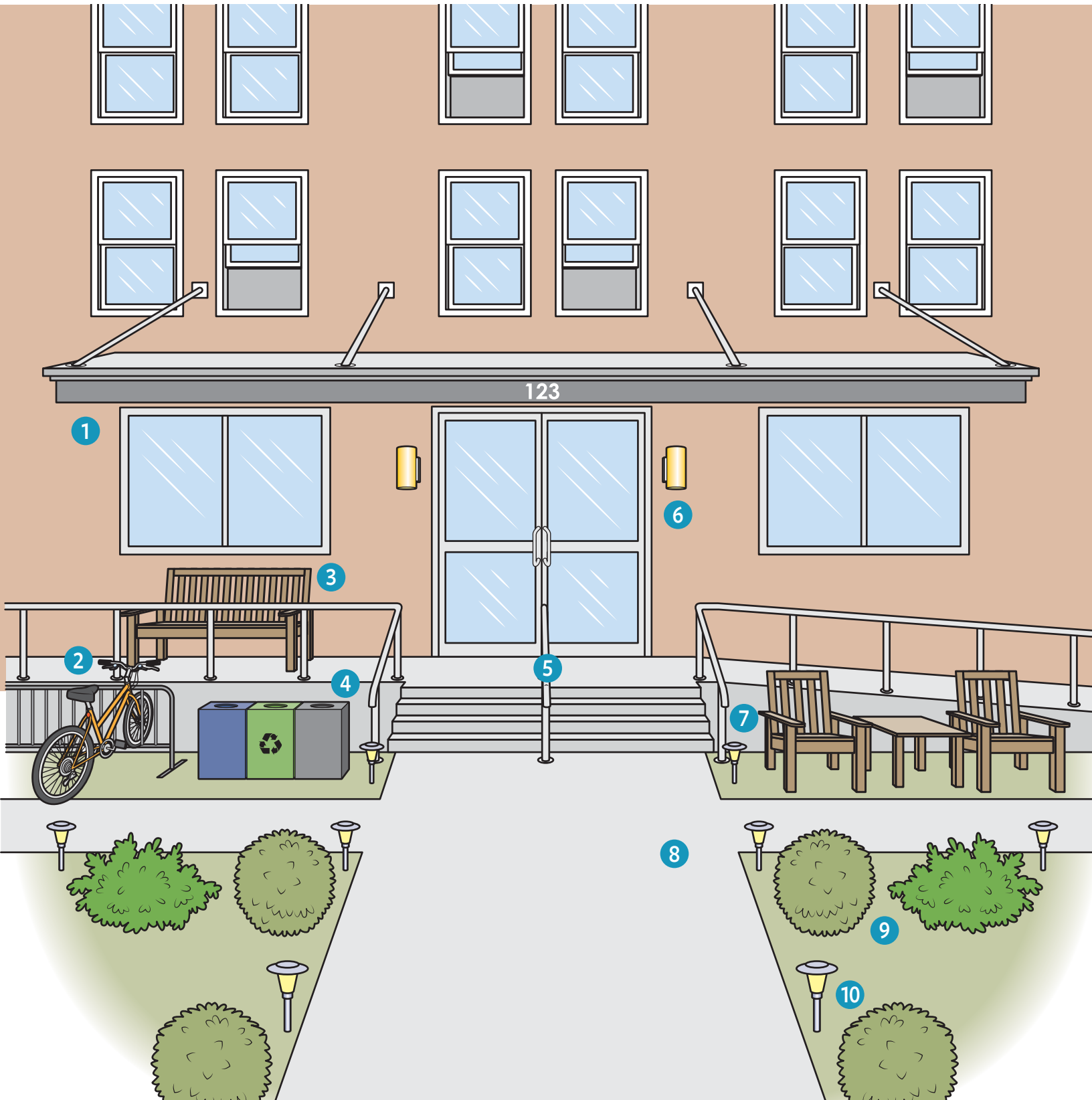

Home Safe Home

The *AARP HomeFit Guide* offers a range of household safety solutions and home modifications that serve people of all ages and, in some cases, older adults specifically. The following aspects of life at home also deserve attention and examination.

Water Safety

- To prevent scalding, residential water heaters are typically set at or below 120°F (49°C). Some health experts advise that people with a compromised immune system or chronic respiratory condition use a setting of 140°F (60°C) to further reduce the risk of bacteria. The illustration at right shows what a temperature control can look like.
- The other element of scalding protection is for shower valves to be pressure balanced, which means the cold water won't all be diverted away when a toilet is flushed, a dishwasher turned on or a washing machine started elsewhere in the home. A plumber can determine whether the fixture is balanced and, if it isn't, install the proper hardware.
- Another safety measure is to have a plumber install a thermostatic valve, so the temperature of the water, not simply the balance of hot and cold water, is controlled.
- Water leaks can cause significant damage, and leaks near wiring and electrical outlets can be dangerous. Placing water leak sensors near the water heater and in potential wet spots will provide an early alert to a problem.
- Insulate exposed hot water pipes to conserve energy and protect against accidental contact.
- Never use an electrical device near a filled sink or tub, even if plugged into a GFCI safety outlet. Note: A GFCI (ground fault circuit interrupter) is sometimes called a GFI (ground fault interrupter). Same device, different names.

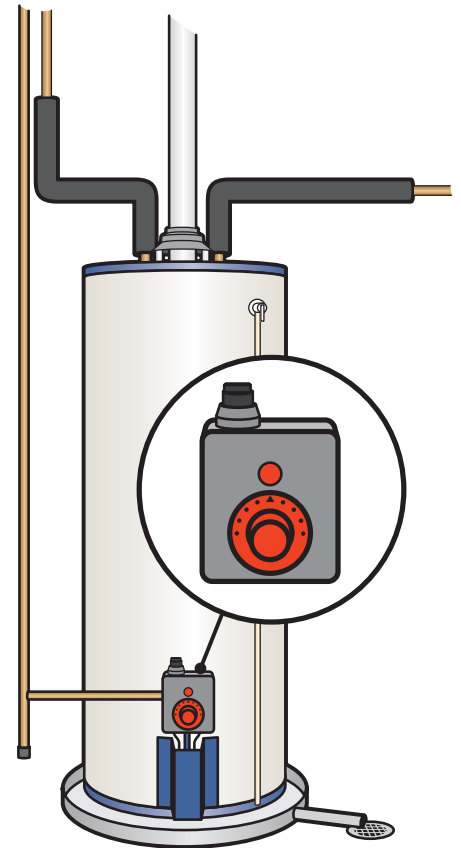

Comfort and Cleanliness

Keep systems (heating, cooling, plumbing) in good working condition by keeping up with maintenance tasks:

- Replace refrigerator, vacuum cleaner and water dispenser filters as indicated in the manual or on the devices themselves.
- If the home uses well water, regularly check the sediment filter and water conditioner salt levels.
- Have fireplaces and woodburning stoves inspected and cleaned before use each season.
- For homes with HVAC systems, replace or clean the air filters every 30 to 90 days (according to the filter manufacturer's instructions). Vacuum or dust the vents and registers. **TIP:** In a home with HVAC and ceiling fans, set the blades to rotate counterclockwise during the summer (to circulate cool air) and clockwise in the winter (to circulate warm air).
- In addition to clearing the dryer lint trap before or after every load of laundry, periodically clean the unit's exhaust vent (the flexible silver tube that connects the dryer to the outdoors). If the cleaning can't be done by someone living in the home, hire a ductwork specialist.

Catching Fires

Residential smoke alarms (or detectors) have evolved greatly since the first low-cost models for homes appeared on the market in the 1960s. For many households, it's become routine to change the smoke detector batteries when changing the clocks twice a year for daylight saving time. But that routine is changing.

In some communities, the zoning code requires new construction homes to be built with hardwired, battery-free smoke alarms. Several states mandate that all newly purchased smoke detectors run on a 10-year battery. The devices cost more, but they're reliable and save both time and money by eliminating the need to repeatedly buy and install new batteries. Some smoke detectors also monitor CO, or carbon monoxide, levels.

Another safety step forward: Many home security systems will contact the authorities when a smoke or

CO alarm goes off. And some models can be checked through a smartphone app.

Every room and hallway should have a smoke detector on the ceiling or high on a wall. The detector used in the kitchen needs to be positioned so it responds to an actual fire risk and not every slightly burnt piece of toast.

In case of real fires, the kitchen needs an ABC-rated fire extinguisher (suitable for fighting fires involving trash, wood, paper, cooking liquids or electrical equipment) that's stored in an easy-to-reach spot. Place lightweight, multipurpose fire extinguishers in accessible locations throughout the home.

With all safety equipment, take the time to register any purchased items or occasionally visit the manufacturers' websites to check for use advisories and recalls.

A Few Points About Pets

Nearly seven out of 10 households in the United States include a pet. The most common types are dogs, cats and freshwater fish (in that order).

A report by the U.S. Centers for Disease Control and Prevention reveals that about 85,000 people suffer nonfatal injuries each year during falls that involve dogs or cats.

Dogs accounted for 88 percent of the tumbles — and females were twice as likely to be injured as men.

A related hazard: tripping over pet toys and accessories.

Since, for pet owners, not having the pet is not an option, the best prevention, according to the National Institute on Aging, is to "Know where your pet is whenever you're standing or walking."

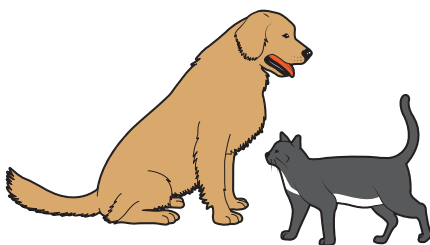

Other ways to protect against pet-related tumbles:

- Limit the number of pet toys in the home (or limit the number of toys that are out and available to the pet at one time).
- Regularly pick up the toys and place them in a designated spot — and *try* to train the pet to do the same.
- When carrying packages, a laundry basket or other bulky items, put the pet in the basement, garage, utility room or a pen until the lifting and moving tasks are done.

Fight Fraud

- When hiring a home improvement or maintenance contractor, ask family and friends if they can recommend a skilled, trustworthy professional.
- Beware of the stranger who shows up or calls and says something along the lines of "I'm finishing a job down the street, so I can give you a good price if you commit today by paying a deposit." Offers like that are usually scams.
- Visit [AARP.org/Fraud](https://www.aarp.org/fraud) to sign up for the AARP Fraud Watch Network's free Watchdog Alerts, find information about local and online scams, report scams, or get help if victimized by a scam.

Quick Fixes

There are several simple solutions that will make a home safer, more efficient and a better “fit” without having to hire a contractor or invest a lot of money in supplies. In fact, some instant improvements are free!

Make It Safer

- Place fire extinguishers in accessible locations throughout the home, especially in the kitchen and in any rooms that are far from an exit or have a fireplace or wood stove. (Check the ratings to be sure the extinguishers are appropriate for home use, and keep an eye on the expiration dates.)
- Install or update smoke and CO detectors. (Many have an expiration date.)
- Replace throw rugs with cushioned, slip-resistant mats. Or use double-sided carpet tape to secure existing floor coverings.
- Add adhesive nonslip strips to uncarpeted steps.
- Gather medications from throughout the home and keep them in a single location. Sort out expired or unneeded medications for safe disposal at a pharmacy or police station. (Remove any personal information from the bottles and boxes or discard the packaging and place the loose pills in a single container or bag.)
- Install motion-sensor night-lights in hallways and bathrooms, near steps and along staircases.
- Replace light bulbs that are too dim or too bright with long-lasting, energy-efficient bulbs. (Check the wattage ratings on the light fixtures to avoid installing bulbs that are too powerful.) If a stool or ladder is needed to reach any fixtures, ask someone to serve as a spotter.
- Store flashlights throughout the home in case of a power outage. Regularly test to check the batteries.
- Maintain a landline phone, especially in the bedroom and kitchen, and/or carry or keep a cell phone nearby.
- Keep a fully powered portable charger or power bank on hand so a cell phone, laptop computer or tablet device can be recharged during a power outage.
- Position and secure electrical and telephone cords along a wall, where they won't be a tripping hazard.

- Install an address number that will be visible to first responders, especially at night.

Find More Resources
[AARP.org/HomeFit](https://www.aarp.org/HomeFit)

Make It a Better ‘Fit’

- Determine where deliveries should be left when no one is home. Post instructions at the door or contact the carrier through its website or by calling its customer service number.
- Locate a bench or table outside the entry door for placing bags when unlocking the door. Also locate a piece of furniture inside for setting down packages and putting shoes on or taking them off.
- Establish a shoe and slipper storage spot near the entrance door. (Any slippers worn in the house should have nonslip soles.)
- When extra lighting is needed, add stick-on battery-operated lights to closets, along steps, in hallways and in the kitchen.
- Place a basket or tote with a handle near stairways for carrying items up and down.
- Add baskets or bins to areas prone to floor clutter.
- Rearrange the contents of kitchen cabinets so frequently used items are in easy to reach locations.
- Add a turntable (available at many housewares stores) to corner cabinets and shelves for efficient storage and easy access.
- Place a chair next to or inside of clothes closets for use while dressing, disrobing or putting clothing away.
- Sort, organize and consolidate belongings in order to donate or dispose of items that are no longer needed or wanted.
- Store reading glasses or a magnifying glass wherever help might be needed for reading small print.

More About Making a Home ‘Fit’

- **AARP Foundation/The Hartford**, [AARPFoundation.org/HeretoStay](https://www.aarpfoundation.org/HeretoStay): Download *Here to Stay: Home Upkeep for All*.
- **AARP Public Policy Institute**, [AARP.org/LivablePolicy](https://www.aarp.org/LivablePolicy): Search for “Expanding Implementation of Universal Design and Visitability Features in the Housing Stock.”
- **American Occupational Therapy Association**, [AOTA.org](https://www.aota.org): Visit the “Patients and Clients” section.
- **National Association of Home Builders**, [NAHB.org](https://www.nahb.org): Search for Certified Aging-in-Place Specialist, or CAPS.

Harder To-Do's

Some home improvements can be do-it-yourself projects for people who have the right skills and tools. When that's not the case, hiring a professional (such as a carpenter, electrician or locksmith) might be the better choice.

- Install dusk-to-dawn light sensors.
- Add a security peephole to exterior doors.
- Replace old door handle locks with bolt-style locks, which are more secure and easier to use.
- Install a video doorbell and lock that can be answered, opened and secured through a smartphone app.
- Replace doorknobs with lever-style handles.
- Install pressure-balancing kitchen and bath faucets.
- Add handrails to steps and staircases outside of the home — and add a second handrail to any interior steps and staircases that have only one.
- Create a zero-step entrance to the home (and ideally do so before one is needed because of injury, illness or age).
- Replace toggle-style light switches with rocker-style switches.
- Install swing-away or swing-clear hinges on doors in order to gain a few extra inches of width in the home's doorways.
- Add bathroom grab (or assist) bars.
- Install a comfort-height toilet.
- Add a bidet attachment to an existing toilet.
- Add motion- or voice-activated lighting in the bathroom.
- Install a handheld, adjustable-height showerhead.
- Replace cabinet and drawer knobs with easier-to-grip D-style handles.
- Remove an over-the-range microwave oven.
- Replace upper kitchen cabinets with open shelving, and/or lower cabinets with drawers.
- Install a laundry chute.
- Clean the dryer's ductwork.
- Wrap exposed hot water pipes with insulation.
- Secure tall furnishings to the wall.
- Mount a flatscreen television on a wall.
- Install an automatic garage door opener.

AARP HomeFit Guide

Writer and Editor: Melissa Stanton, Senior Advisor, AARP Livable Communities

Contributing Editor: Danielle Arigoni, Director, AARP Livable Communities

Art Director: Mimi Park, Design Park, Inc.

Illustrator: Colin Hayes, for Design Park, Inc.

Copy Editor: Don Armstrong

AARP HomeFit Guide Advisory Council

- Elizabeth Bradley, AARP Integrated Communications and Marketing
- James Brooks, AARP Office of Community Engagement
- Sonya Chung-Hirano, Senior Housing Consultant
- Craig Eichelman, AARP Missouri
- Heather Finn, AARP Services Inc.
- Jake Fratangelo, AARP Enterprise Partnerships
- Jill Friend, AARP Foundation
- Bob Gerken, AARP North Carolina
- Esther Greenhouse, Certified Aging-in-Place Specialist
- Shannon Guzman, MCP, AARP Public Policy Institute
- Rodney Harrell, PhD, AARP Public Policy Institute
- Cindy Hellyar, The Hartford Center for Mature Market Excellence
- Karen Kafantaris, AARP Michigan*
- Miranda Kemp, AARP Information Technology Services
- Mike Kulick, AARP Office of Community Engagement
- Daphne Kwok, AARP Multicultural Leadership
- Nicole Macias, AARP Office of Community Engagement
- Brenna McCalick, AARP Foundation
- Claire M. Mulry, OTD, OTR, Certified Aging-in-Place Specialist, Kean University, Department of Occupational Therapy
- Emily Nabors, MGS, University of Southern California, Leonard Davis School of Gerontology
- Jon Pynoos, PhD, University of Southern California, Leonard Davis School of Gerontology
- Mashell Sourjohn, AARP Oklahoma
- Kris Thompson, Oak Hill Technology
- Susan Wang, AARP California
- Katherine White, AARP Turnkey Programs

* Karen Kafantaris is the co-creator of the AARP HomeFit program and workshop, which inspired the first edition of the AARP HomeFit Guide.



HomeFit Guide

Most houses and apartments are designed for young, able-bodied adults and don't meet the needs of older residents or people with disabilities.

In fact, in many parts of the United States, most housing units were built more than a generation ago to serve a population of family households, generally consisting of two parents and at least two children.

But America circa 2020 is a nation in which the dominant household type, accounting for nearly 30 percent of all households, consists of single adults living alone.

By 2030, one in five people in the U.S. will be age 65 or over. And it's projected that by 2034, such older adults will outnumber children under 18 for the first time ever.

America's housing stock doesn't fit a rapidly changing and rapidly aging population.

That's where the *AARP HomeFit Guide* comes in.

The guide examines what makes a home aging-friendly. And it suggests the kinds of designs and modifications that can make a home safer, more comfortable and a better "fit" for its residents — of every age.

A LOOK INSIDE!

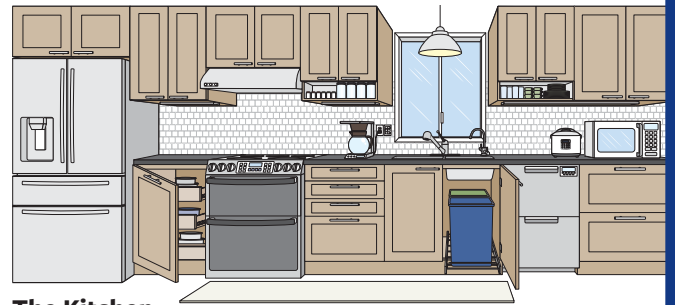

The Kitchen



The Bedroom

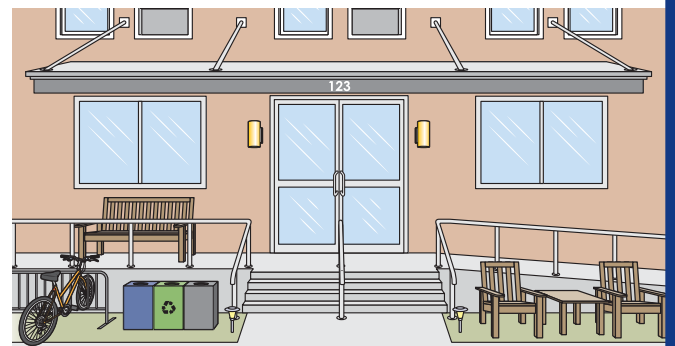

Outdoor Places and Shared Spaces



Find the **AARP HomeFit Guide** online at [AARP.org/HomeFit](https://www.aarp.org/HomeFit)

Learn when AARP releases new livability publications. Sign up for the free, weekly AARP Livable Communities e-Newsletter by visiting [AARP.org/LivableSubscribe](https://www.aarp.org/LivableSubscribe) or texting the word LIVABLE to 50757.